



FLEXIBLE
BARRIERS
SAFER
WORKPLACE

OCTOBER 2024



CONTENTS

01	Rack Protections	page 12	09	Loading Bay Protections	page 56
02	Bollards	page 20	10	Column Protections	page 62
03	Cold Line	page 24	11	Corner Protections	page 68
04	Ground Level Protections	page 28	12	Kerb	page 72
05	Traffic Barriers	page 32	13	Wall Protections	page 76
06	Pedestrian Barriers	page 36	14	Accessories	page 82
07	Gates	page 46	15	Tech Solutions	page 90
08	Industrial Door Protections	page 52			



Flexible safety solutions

To make work environments safe wherever there is movement of vehicles, goods and people.

Soluzioni di sicurezza flessibili

Per rendere sicuri gli ambienti di lavoro ovunque ci sia movimento di veicoli, merci e persone.

Solutions de sécurité flexibles

Pour rendre les environnements de travail sûrs lorsqu'il y a un mouvement de véhicules, de marchandises et de personnes.

Soluciones flexibles de seguridad

Hace mas seguros los entornos de trabajo donde se mueven vehículos, mercancías y personas.

mpm
FLEXIBLE PROTECTIONS
WAREHOUSE



MPM Materials



REFLEX ALPHA
Highly UV-resistant
Maintains its colour
over time

REFLEX
RESISTANT AND FLEXIBLE

FROSTEX
RESISTANT TO LOW TEMPERATURES

Durability Through Time	High Flexibility	RoHS compliant Compliance With EU Directive 2015/863 (ROHS)
100% Recyclable	Self Extinguishing V0	Anti-scratch Material
Coloured Material. No Repainting Required	Easy To Clean	Mold Resistant
Non-toxic	Resistant to Chemicals	Resistant to Humidity & Saline Substances

Temperature Range: -30° + 50° C	High Flexibility	RoHS compliant Compliance With EU Directive 2015/863 (ROHS)
100% Recyclable	HB Flammability rating according to UL 94	Suitable for food contact
Coloured Material. No Repainting Required	Resistant to Chemicals	Mold Resistant
Non-toxic	Resistant to Humidity & Saline Substances	

FIRE CERTIFICATION FOR MPM REFLEX

NEWS

OUR POLYMER CONFIRMS THE V0 SELF-EXTINGUISHING CLASS

MPM barriers are classified V0, according to the international UL94 standard. Protections in Reflex technopolymer:

- Low fire risk;
 - Self-extinguishing;
 - Don't spread flames and stop burning within few seconds.
- The installation of our barriers lowers fire risk compared to other barriers made of alternative polymers, not V0-Classified.

Le barriere MPM sono classificate V0, secondo lo standard internazionale UL94. Le protezioni in tecnopolimero Reflex:

- Hanno un basso carico d'incendio;
- Sono autoestinguenti;
- Non propagano la fiamma e smettono di bruciare entro pochi secondi.

L'installazione delle nostre barriere riduce il carico d'incendio rispetto ad altre barriere in polimeri alternativi, non classificati V0.

Les barrières MPM sont classées V0, selon la norme internationale UL94. Les protecteurs en technopolymère Reflex:

- Ils ont une faible charge d'incendie;
- Ils sont auto-extinguibles;
- Ils ne propagent pas la flamme et cessent de brûler en quelques secondes.

La présence de nos barrières réduit la charge d'incendie par rapport à d'autres barrières en polymères alternatifs, non classées V0.

Las barreras MPM están clasificadas como V0, según la norma internacional UL94. Las protecciones de tecnopolímero Reflex:

- Tienen una baja carga de fuego;
- Son autoextinguibles;
- No propagan la llama y dejan de arder en unos segundos.

La instalación de nuestras barreras reduce la carga de fuego en comparación con otras barreras de polímero alternativas, no clasificadas como V0.



REFLEX
RESISTANT AND FLEXIBLE

IS FIRE RESISTANT
CLASS V-0



At MPM, we believe in a safer future from every perspective.

We produce solutions to keep people safe under all circumstances, and that's why we commit to making our production processes increasingly more sustainable.

MPM Green

We are a "closed-loop" company, connected to a network of external businesses that allows us to eliminate waste from our production chain by recycling the "excess" and processing it to give it new life.

All of our products become useful, one way or the other, and waste is always avoided.

Siamo un'azienda a "circuito chiuso", collegata a una rete di imprese esterne che ci permette di eliminare gli sprechi dalla nostra catena di produzione riciclando le "eccedenze" e trattandole per dar loro una nuova vita.

Tutti i nostri prodotti diventano utili, in un modo o nell'altro, e gli sprechi sono sempre evitati.

Nous sommes une entreprise en "circuit fermé", connectée à un réseau d'entreprises externes. Nous recyclons les excédents de production pour leur donner une nouvelle vie, évitant ainsi les déchets.

Tous nos produits trouvent utilité dans ce processus.

Somos una empresa en "circuito cerrado", conectada a una red de negocios externos. Reciclamos los excesos de producción para darles nueva vida, evitando desperdicios y promoviendo la sostenibilidad ambiental.

Todos nuestros productos encuentran utilidad en este proceso.



WATER USAGE

All water used is internally recycled to reduce pollution and maximize its utilization.

Tutta l'acqua usata è internamente riciclata per ridurre l'inquinamento e massimizzarne l'utilizzo.

Toute l'eau utilisée est recyclée en interne pour réduire la pollution et maximiser son utilisation.

Todo el agua utilizada se recicla internamente para reducir la contaminación y maximizar su uso.



ZERO WASTE GOAL

Our products are crafted from 100% recyclable, non-toxic materials.

I nostri prodotti sono realizzati con materiali al 100% riciclabili e non tossici.

Nos produits sont fabriqués avec des matériaux 100% recyclables et non toxiques.

Nuestros productos están hechos de materiales 100% reciclables y no tóxicos.



CLEAN ENERGY

Our Italian facilities rely on solar power, cutting carbon emissions.

Le nostre strutture in Italia usano energia solare, tagliando le emissioni di carbonio.

Nos installations italiennes fonctionnent à l'énergie solaire, réduisant les émissions de carbone.

Nuestras instalaciones en Italia utilizan energía solar, reduciendo las emisiones de carbono.

MPM Systems

Innovation made simple

With our innovative complementary systems you can customize your solutions.

Con i nostri innovativi sistemi complementari puoi personalizzare le tue soluzioni.

Avec nos systèmes complémentaires innovants, vous pouvez personnaliser vos solutions.

Con nuestros sistemas complementarios innovadores, puedes personalizar tus soluciones.

LINK

Customize crossbar height at any time

Personalizza l'altezza del traverso in qualsiasi momento

Personnalisez la hauteur de la barre transversale à tout moment

Personaliza la altura de la barra transversal en cualquier momento

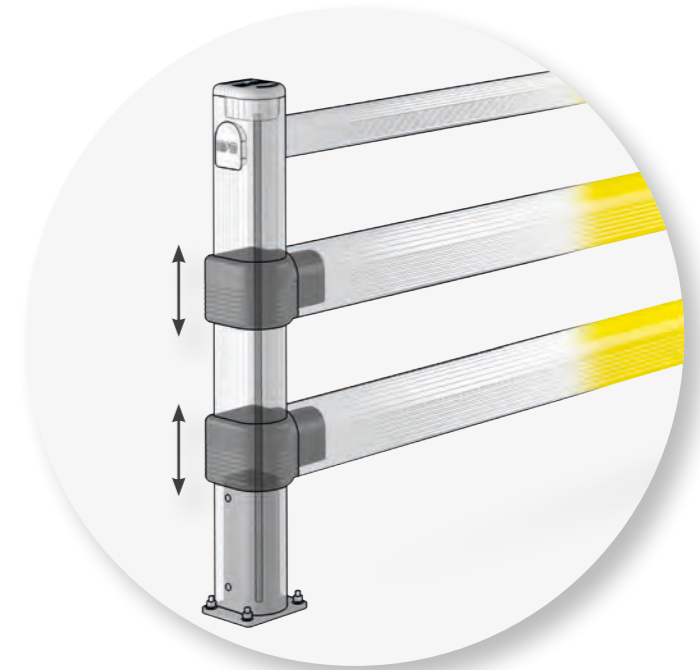

STANDARD

Our STANDARD system is simple and intuitive to use thanks to its few components.

Il nostro sistema STANDARD è semplice e intuitivo da usare grazie alle poche componenti.

Notre système STANDARD est simple et intuitif à utiliser grâce à ses quelques composants.

Nuestro sistema estándar es simple e intuitivo de usar gracias a sus pocas componentes.

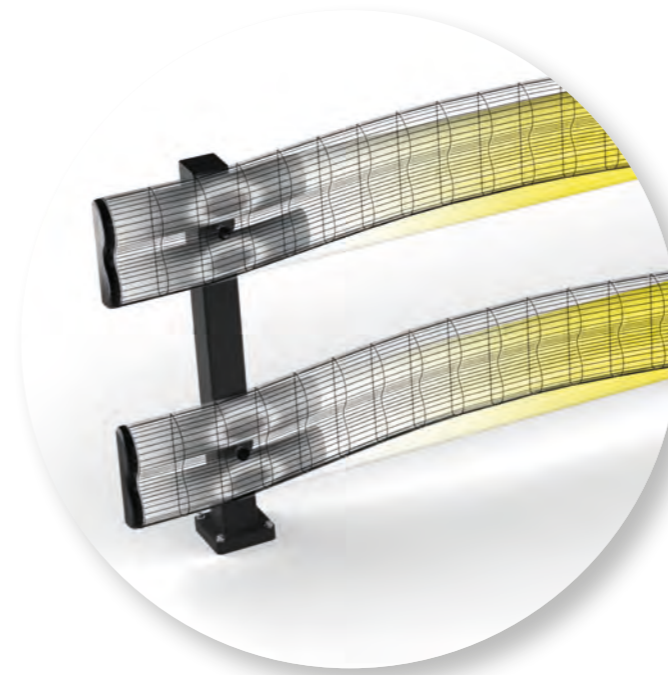
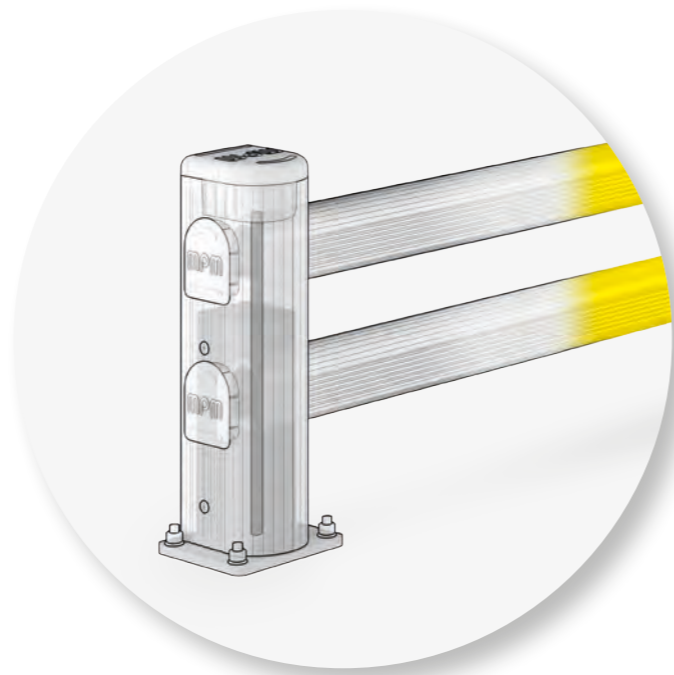

B-FLEX

Protection system with a reinforced profile, twice as flexible and shock-absorbent.

Sistema di protezioni con profilo rinforzato, doppiamente flessibile e assorbente.

Système de protection avec profil renforcé, doublement flexible et absorbant.

Sistema de protección con perfil reforzado, más flexible y capaz de absorber perfectamente los impactos.

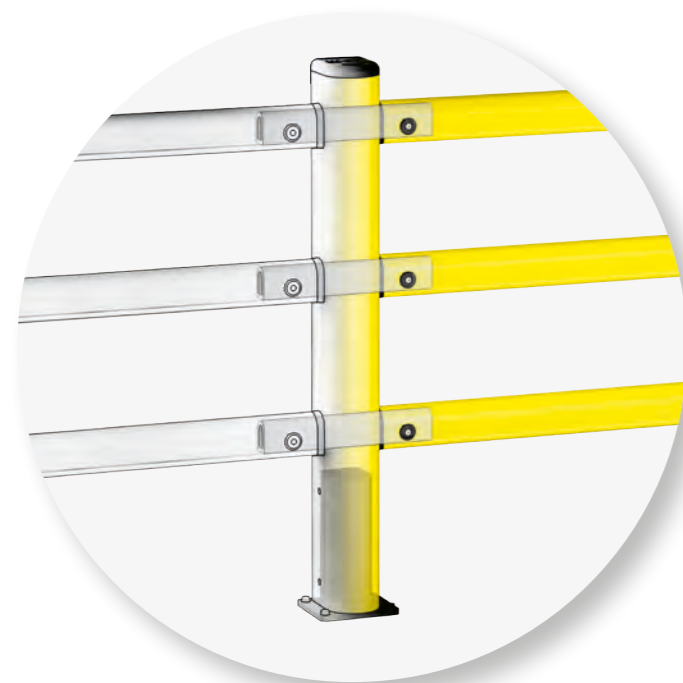

PIN

Enhanced strength and greater impact absorption

Maggiore resistenza e maggiore assorbimento degli impatti

Résistance accrue et absorption des chocs

Mayor resistencia y mayor absorción de impactos

Discover our systems!

Ask our team how to best use these innovative systems to meet your safety needs.

Chiedi al nostro team come utilizzare al meglio questi sistemi innovativi per soddisfare le tue esigenze di sicurezza.

Demandez à notre équipe comment utiliser au mieux ces systèmes innovants pour répondre à vos besoins en matière de sécurité.

Pregunta a nuestro equipo cómo utilizar de la mejor manera estos sistemas innovadores para satisfacer tus necesidades de seguridad.





RACK PROTECTIONS

01

OUR PROFILES FIT ALL RACKS

Full range of technopolymer profiles for protection of rackings.

Gamma completa di profili in tecnopolimero per la protezione delle scaffalature.

Complète gamme de profilés en tecnopolimère pour la protection d'étagères.

Gama completa de perfiles de tecnopolímeros para las protecciones de estanterías.

Two side shock absorbers made of soft material to absorb impacts during pallet placement on the shelf.

A central shock absorber made of soft material to absorb frontal impacts.

Hard outer coating, scratch-resistant and easy to clean.

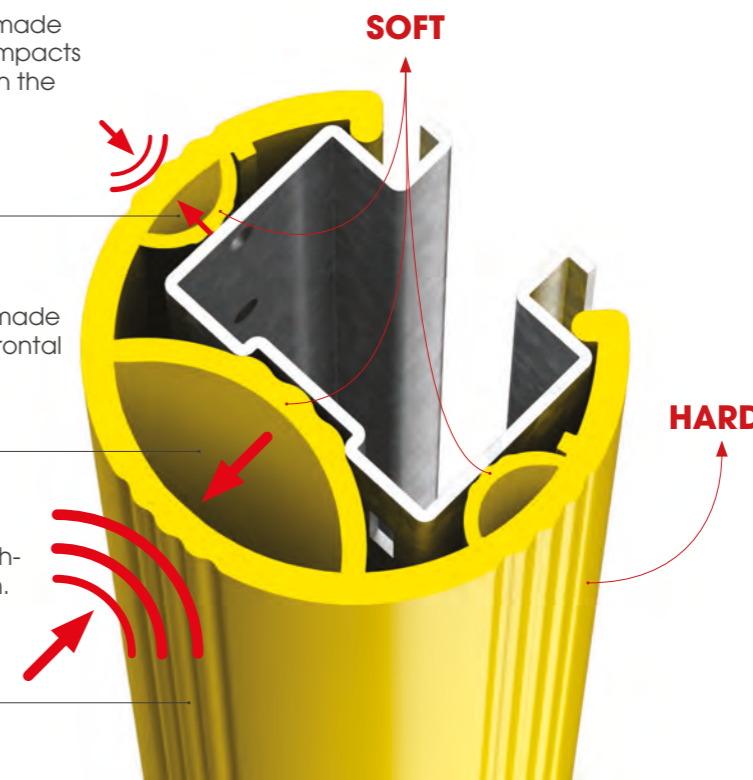

RP

Available for



**EASY TO INSTALL
WITH RP CLICK**



**SOFT MATERIAL
INSIDE**



**CUSTOMIZED
SOLUTIONS TO
FIT ALL UPRIGHTS**



RPS



Model **Small**
Height **400, 600 mm**
Packing **6 pcs / box**
Packing **115 pcs / big parcel**
For Indoor Use Only
Colour ●

RPM



Model **Medium**
Height **400, 600 mm**
Packing **4 pcs / box**
Packing **80 pcs / big parcel**
For Indoor Use Only
Colour ●

RPL



Model **Large**
Height **400, 600 mm**
Packing **2 pcs / box**
Packing **52 pcs / big parcel**
For Indoor Use Only
Colour ●

RPL XL



Model **Extra Large**
Height **600 mm**
Packing **To be defined**
For Indoor Use Only
Colour ●

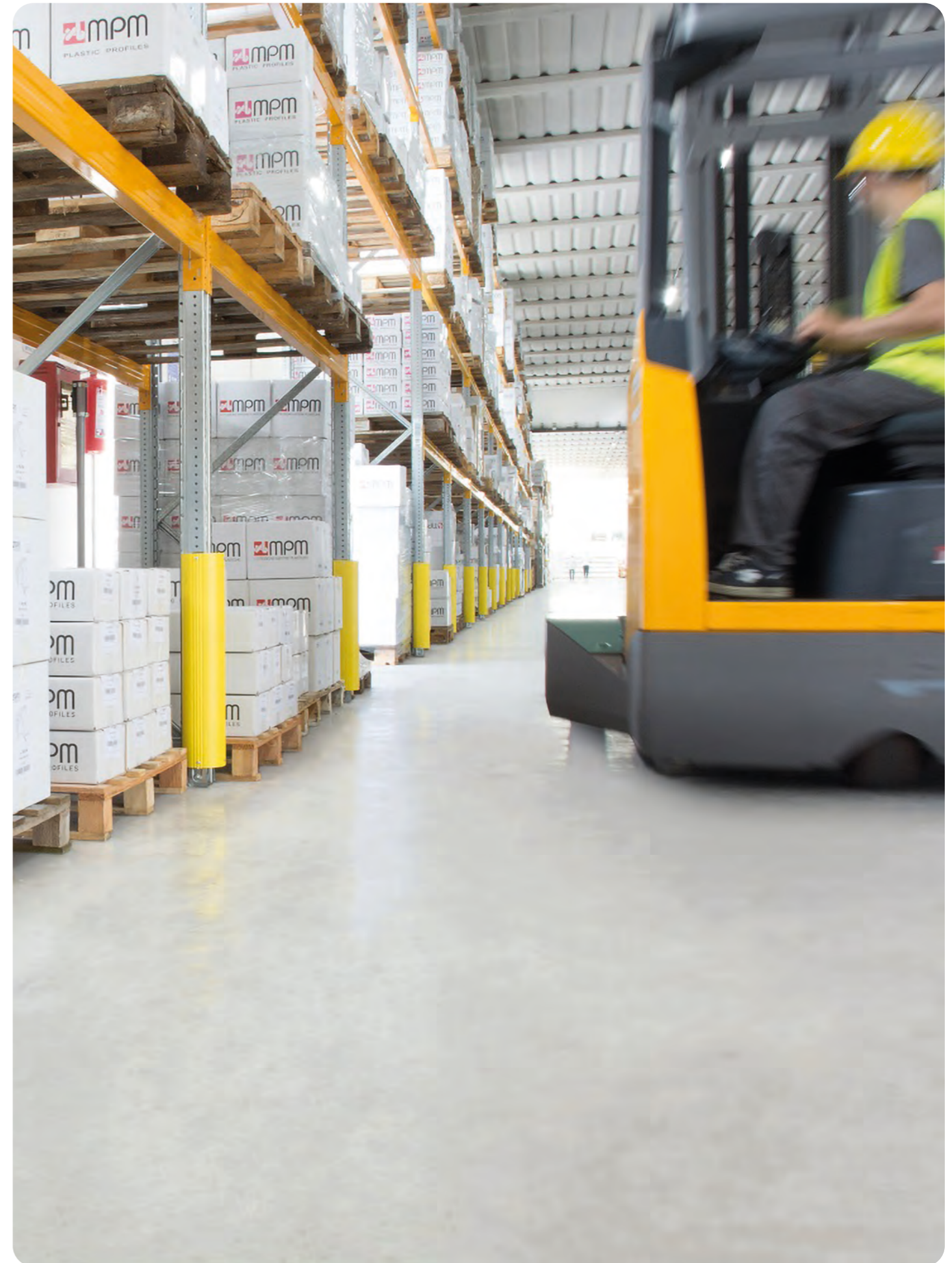

RACK CORNER



RACK CORNER



Heavy Load

Height **500 mm**
 Fixing **Included**
For Indoor Use Only
 Colour



LM



Ask us about our **2-UNITS RACK END BARRIER** going up to 4000mm width

SM RE



Light Load

Height **350 mm**
 Width **250 - 1500 mm (50 increments)**
 Fixing **Included**
 Colour

LM RE



Heavy Load

Height **420 mm**
 Width **250 - 2400 mm (50 increments)**
 Fixing **Included**
 Colour

LINK SINGLE RE



Heavy Load

Height **500, 800 mm**
 Width **400 - 2400 mm (50 increments)**
 Fixing **Included**
 Colour

LM/1 LINK RE



Heavy Load

Height **420 mm**
 Width **400 - 2400 mm (50 increments)**
 Fixing **Included**
 Colour

LINK LM RE



Heavy Load

Height **500, 800 mm**
 Width **400 - 2400 mm (50 increments)**
 Fixing **Included**
 Colour



FENCE



FENCE 90



Light Load

Height 400 mm
Width 300 - 2400 mm
(50 increments)
Fixing Included
Colour ● ●

FENCE 150



Heavy Load

Height 550 mm
Width 400 - 2400 mm
(50 increments)
Fixing Included
Colour ● ●

FENCE 150 REF



Heavy Load

Height 550 mm
Width 400 - 2400 mm
(50 increments)
Fixing Included
Colour ● ●

FENCE LINK



Heavy Load

Height 550 mm
Width 400 - 2400 mm
(50 increments)
Fixing Included
Colour ● ●



BFLEX

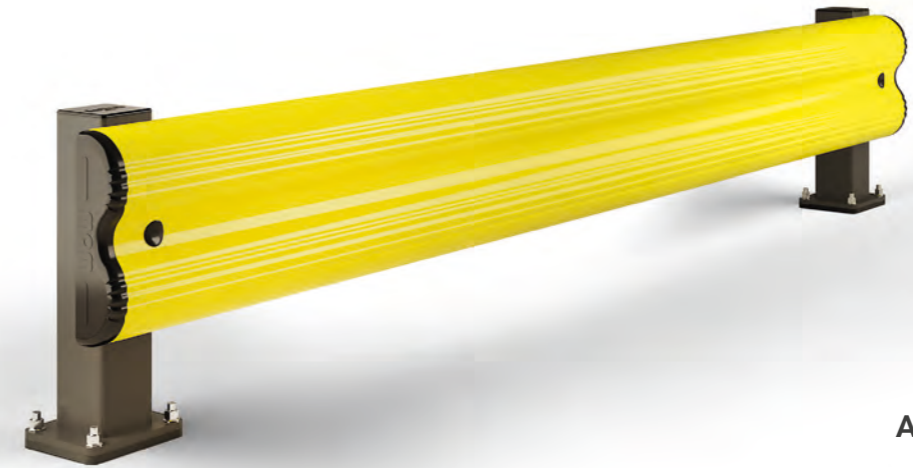

SHOCK
ABSORBER PAD

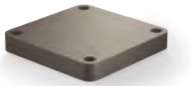

INCLUDED

BFLEX.FRONT/1 RE



Heavy Load

Height 450 mm
Width 250 - 2400 mm
(50 increments)
Fixing Included
Colour ●

BFLEX.COM/1 RE



Heavy Load

Height 450 mm
Width 550 - 2400 mm
(50 increments)
Fixing Included
Colour ●





Designed to protect gates, doors and all sensible structures in warehouses and logistic areas.

Progettati per proteggere cancelli, porte e tutte le strutture sensibili in magazzini e aree logistiche.

Conçus pour protéger les portails, les portes et toutes les structures sensibles dans les entrepôts et les zones logistiques.

Diseñados para proteger puertas, portones y todas las estructuras sensibles en almacenes y áreas logísticas.

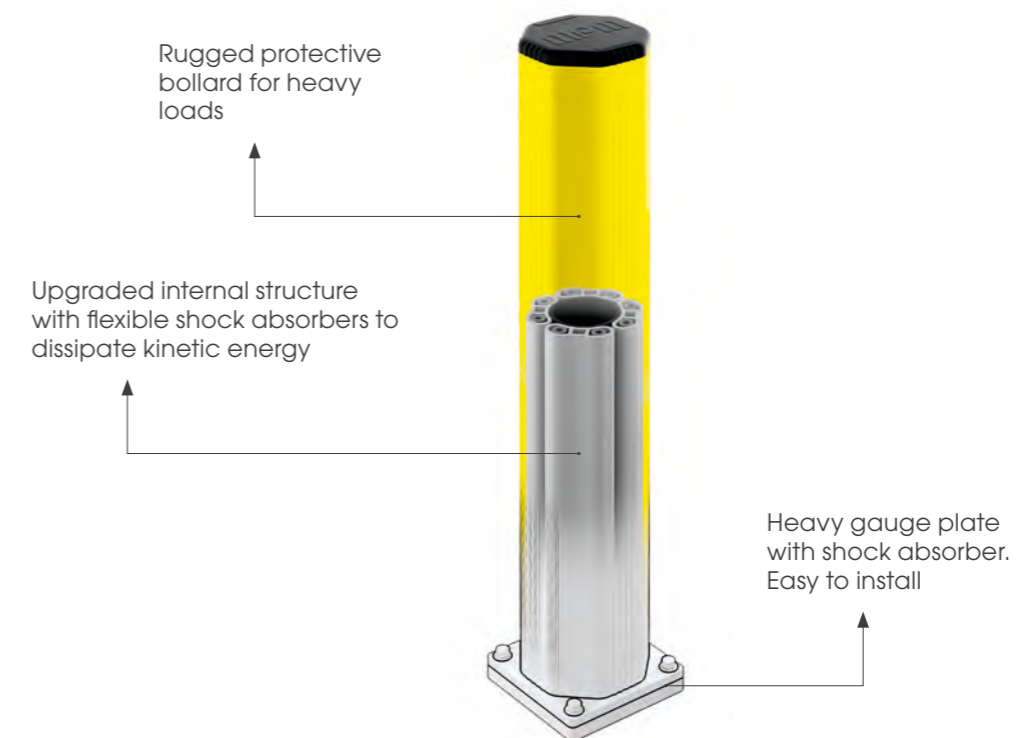

GRD

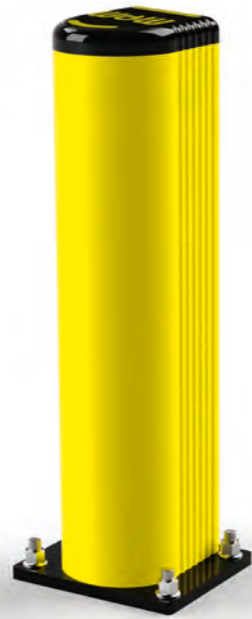

SHOCK
ABSORBER PAD

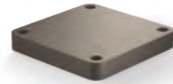

INCLUDED
FOR PLUS

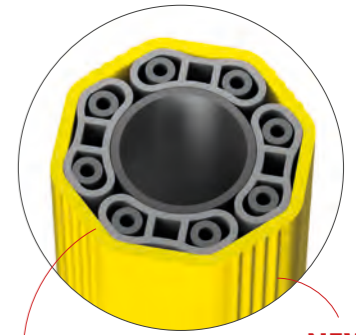
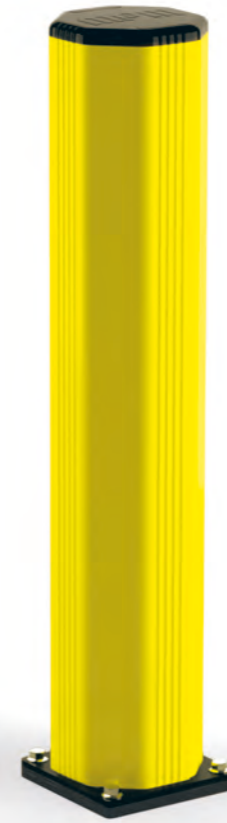

FLEXIBLE

NEW
ANTISHOCK
BUMPER

GRD 90



Light Load

Height **250, 1150 mm**
Fixing **Included**
Colour **Yellow, Grey**

GRD 150



Heavy Load

Height **500, 800, 1150 mm**
Fixing **Included**
Colour **Yellow, Grey**

GRD 150 PLUS



Heavy Load

Height **500, 800, 1150 mm**
Fixing **Included**
Colour **Yellow, Grey**

GRD 200



Heavy Load

Height **1200, 2000 mm**
Fixing **Included**
Colour **Yellow**

SHOCK
ABSORBER PAD

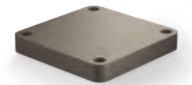

INCLUDED





FROSTEX
RESISTANT TO LOW TEMPERATURES

-30° RESISTANT TO LOW TEMPERATURES

Specific solutions for protection of environments with negative temperatures. They are suitable to protect corners, entrances, gates, panels and walls in cold rooms

Soluzioni specifiche per la protezione di ambienti a temperatura negativa. Ideali per proteggere angoli sporgenti, accessi e portoni, pannelli e pareti di celle frigorifere.

Solutions spécifiques pour la protection des environnements à température négative. Idéal pour protéger les angles, les entrées et les portes, les panneaux et les murs des chambres froides.

Soluciones específicas para proteger los entornos de temperatura negativa. Son ideales para proteger esquinas, entradas y puertas, paneles y paredes de las cámaras frigoríficas.

Suitable for the food industry



Thanks to its hygienic structure it does not allow accumulation of dirt and bacteria

ROD

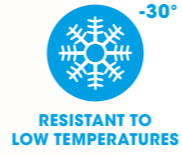

ROD 70



ROD 120



Light Load

Height **266 mm**
 Fixing **Included**
 Colour ●

Heavy Load

Height **433, 560, 800 mm**
 Fixing **Included**
 Colour ●



ROD FLOOR

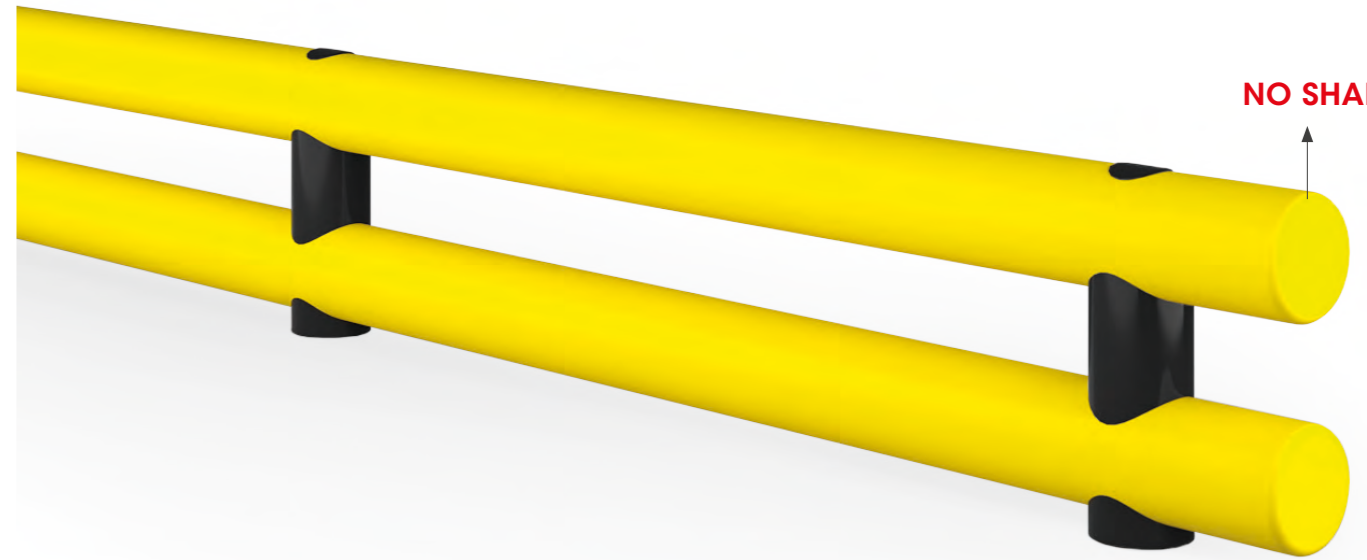
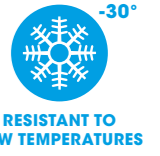

NO SHARP EDGES

RF 70



RF 100



RF 120



RF 120 DOUBLE



Light Load

Height **110 mm**
 Length **500, 1000, 1500, 2000, 3000 mm**
 Fixing **Included**
 Colour ●

Heavy Load

Height **135 mm**
 Length **500, 1000, 1500, 2000, 3000 mm**
 Fixing **Included**
 Colour ●

Heavy Load

Height **140 mm**
 Length **500, 1000, 1100, 1500, 2000, 2500, 3000 mm**
 Fixing **Included**
 Colour ●

Heavy Load

Height **400 mm**
 Length **500, 1000, 1100, 1500, 2000, 2500, 3000 mm**
 Fixing **Included**
 Colour ●





04 | GROUND LEVEL PROTECTIONS

Bumper systems designed to prevent damages to structures and to protect from low forks of forklifts.

Sistemi antiurto pensati per prevenire i danni alle strutture e per proteggere dalle forche basse dei carrelli elevatori.

Systèmes de pare-chocs conçus pour prévenir les dommages aux structures et protéger contre les fourches basses des chariots élévateurs.

Sistemas de parachoques diseñados para prevenir daños en las estructuras y proteger contra las horquillas bajas de los carretes elevadores.

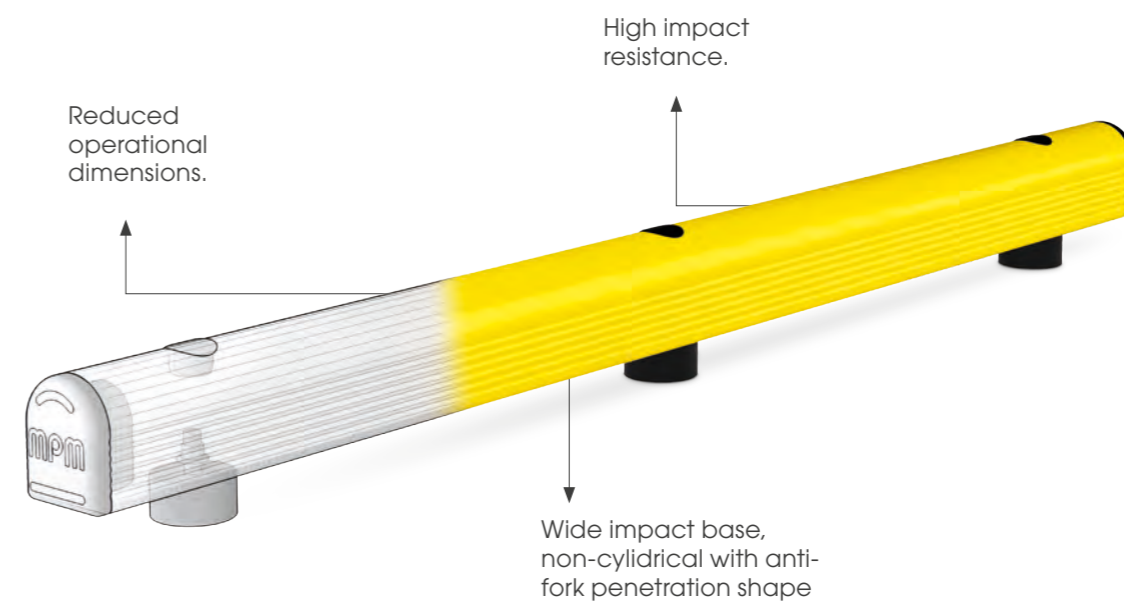

GR



GR 90



GR 150



TRUCK LINE



Light Load

Height **140 mm**
 Length **500, 750, 1000, 1500, 2000, 3000, 4000 mm**
 Fixing **Included**
 Colour **● ●**

Heavy Load

Height **200 mm**
 Length **500, 750, 1000, 1250, 1500, 1750, 2000, 2250, 2500, 3000, 4000 mm**
 Fixing **Included**
 Colour **● ●**

Heavy Load

Height **150 mm**
 Length **500, 750, 1000, 1250, 1500, 1750, 2000, 2250, 2500, 3000, 4000 mm**
 Fixing **Included**
 Colour **● ●**



GR MODULAR



GRIN 90



GRIN 150



GR 150 Modular

NEW



TRUCK LINE Modular

NEW



Light Load

Height **140 mm**
 Length **600 - 1500 mm (50 Increments)**
 Fixing **Included**
 Colour **● ●**

Heavy Load

Height **200 mm**
 Length **800 - 2000 mm (50 Increments)**
 Fixing **Included**
 Colour **● ●**

Heavy Load

Height **200 mm**
 Length **500, 750, 1000, 1250, 1500, 1750, 2000, 2250, 2500, 3000, 4000 mm**
 Fixing **Included**
 Colour **● ●**

Heavy Load

Height **150 mm**
 Length **500, 750, 1000, 1250, 1500, 1750, 2000, 2250, 2500, 3000, 4000 mm**
 Fixing **Included**
 Colour **● ●**





Traffic barriers are a solution designed for the protection of people, infrastructures, machinery, and for the demarcation of moving vehicles.

Le barriere antiurto sono una soluzione studiata per la protezione di persone, infrastrutture, macchinari e per la delimitazione di veicoli in movimento.

Les barrières de circulation sont une solution conçue pour la protection des personnes, des infrastructures, des machines et pour la délimitation des véhicules en mouvement.

Las barreras antigolpes para vehículos son una solución diseñada para la protección de personas, infraestructuras, maquinaria y para la delimitación de vehículos en movimiento.

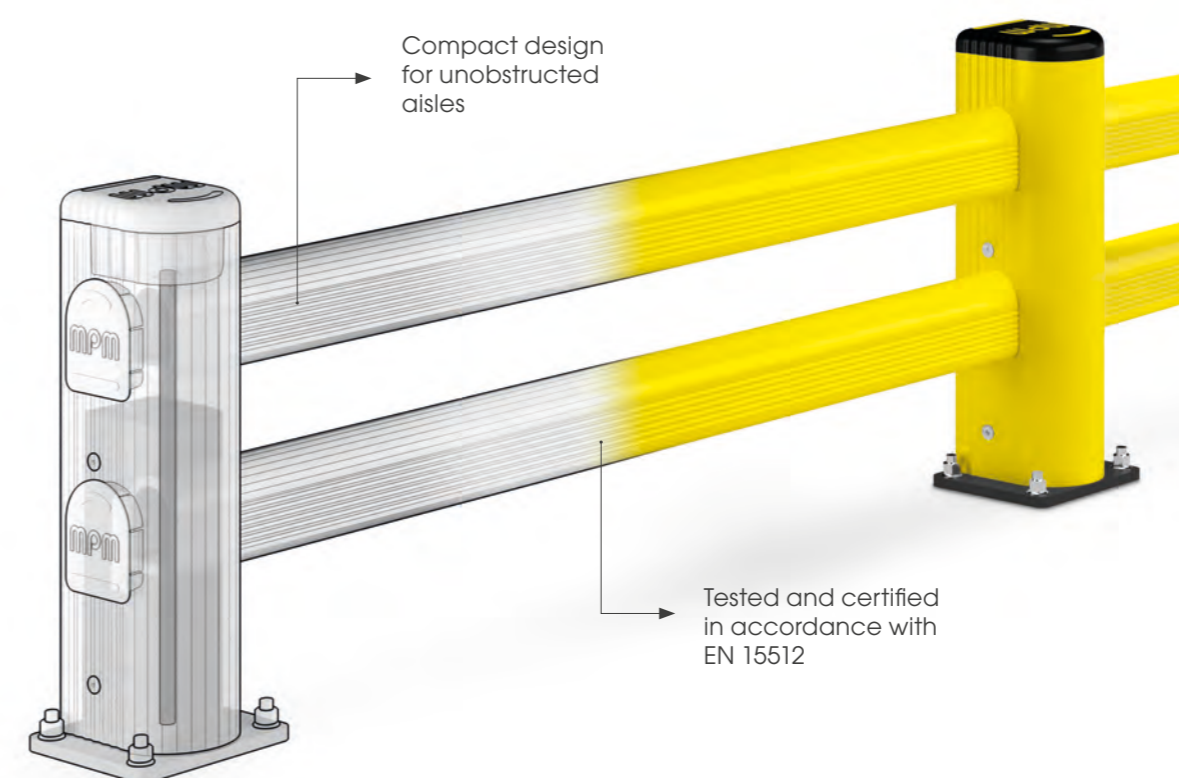

LM MODULAR



SM Modular



Light Load

Height **350 mm**
 Standard Module **250 - 1500 mm (250 increments)**
 Fixing **Included**
 Colour ● ●

LM Modular



Heavy Load

Height **420 mm**
 Standard Module **250 - 2000 mm (250 increments)**
 Fixing **Included**
 Colour ● ●

LINK SINGLE Modular



Heavy Load

Height **500, 800 mm**
 Standard Module **500 - 2000 mm (250 increments)**
 Fixing **Included**
 Corner **External Available**
 Colour ● ●

LM/1 LINK Modular



Heavy Load

Height **420 mm**
 Standard Module **500 - 2000 mm (250 increments)**
 Fixing **Included**
 Corner **External Available**
 Colour ● ●

LINK LM Modular



Heavy Load

Height **500, 800 mm**
 Standard Module **500 - 2000 mm (250 increments)**
 Fixing **Included**
 Corner **External Available**
 Colour ● ●



BFLEX MODULAR



SHOCK ABSORBER PAD

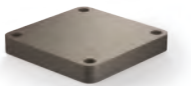

INCLUDED

BFLEX.FRONT/1 Modular



Heavy Load

Height **450 mm**
 Standard Module **750 - 2000 mm (250 increments)**
 Fixing **Included**
 Colour ●

BFLEX.COM/1 Modular



Heavy Load

Height **450 mm**
 Standard Module **750 - 2000 mm (250 increments)**
 Fixing **Included**
 Corner **Available**
 Colour ●





New system specific for the protection of pedestrians and resistant to forklift movements with different load types.

Sistema di profili antiurto specifico per la protezione delle aree pedonali dai carrelli in movimento con diverse portate di carico.

Système bumper, spécifique pour protéger les zones piétonnes contre les mouvements des chariots.

Sistema específico de perfiles antichoque para la protección de zonas peatonales de carros en movimiento con diferentes capacidades de carga.

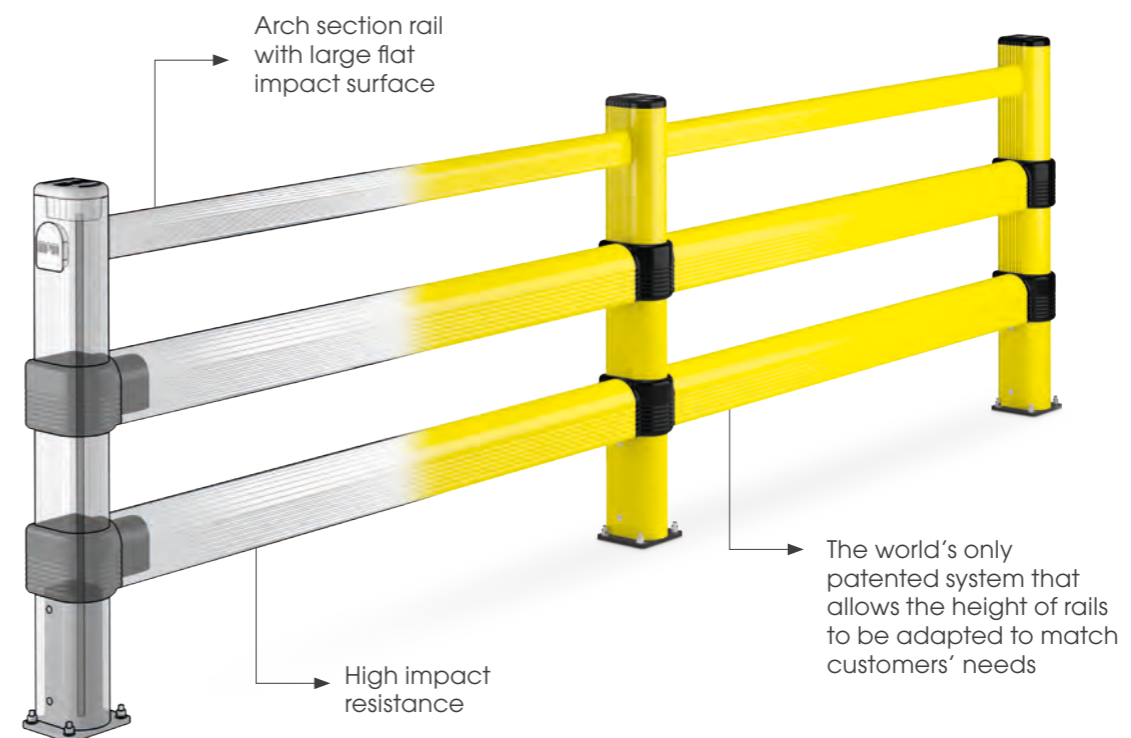

PEDESTRIAN 90



HAND RAIL



For Indoor Use Only



Height **1100 mm**
 Standard Module **250 - 1500 mm (250 Increments)**
 Corner **Available**
 Fixing **Included**
 Colour **● ●**

PED 90



Height **1100 mm**
 Standard Module **250 - 1500 mm (250 Increments)**
 Corner **Available**
 Fixing **Included**
 Colour **● ●**

PED 90 LINK



Height **1100 mm**
 Standard Module **500 - 2000 mm (250 Increments)**
 Fixing **Included**
 Colour **● ●**

PED 90 GL REF



Height **1100 mm**
 Standard Module **750 - 2000 mm (250 Increments)**
 Fixing **Included**
 Colour **● ●**



LINK 120

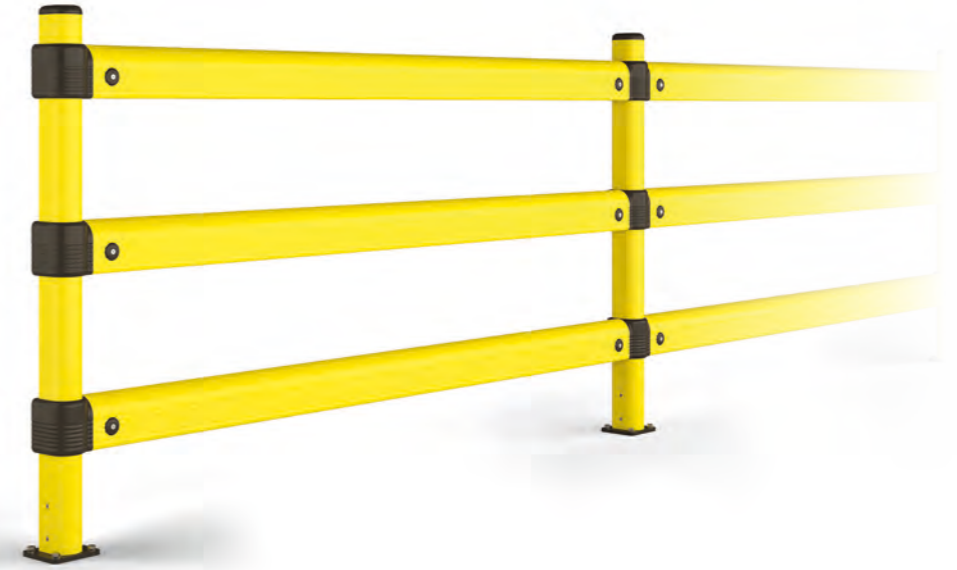

LINK 120/1



Height **1100 mm**
 Standard Module **500 - 2000 mm (250 Increments)**
 Fixing **Included**
 Colour **● ●**

LINK 120/2



Height **1100 mm**
 Standard Module **500 - 2000 mm (250 Increments)**
 Fixing **Included**
 Colour **● ●**

LINK 120/3



Height **1100 mm**
 Standard Module **500 - 2000 mm (250 Increments)**
 Fixing **Included**
 Colour **● ●**



PEDESTRIAN 150







PED 150



PED 150 TL



 Heavy Load
 Height **1100 mm**
 Standard Module **250 - 2000 mm (250 Increments)**
 Corner **Available**
 Fixing **Included**
 Colour 

 Heavy Load
 Height **1100 mm**
 Standard Module **750 - 2000 mm (250 Increments)**
 Corner **Available**
 Fixing **Included**
 Colour 



LINK 150



LINK 150/1





LINK 150/2





LINK 150/3



 Heavy Load
 Height **1100 mm**
 Standard Module **500 - 2000 mm (250 Increments)**
 Corner **External Available**
 Fixing **Included**
 Colour 

 Heavy Load
 Height **1100 mm**
 Standard Module **500 - 2000 mm (250 Increments)**
 Corner **External Available**
 Fixing **Included**
 Colour 

 Heavy Load
 Height **1100 mm**
 Standard Module **500 - 2000 mm (250 Increments)**
 Corner **External Available**
 Fixing **Included**
 Colour 



PEDESTRIAN 150 LINK



PED 150 LINK



CHOOSE THE HEIGHT YOU NEED!



-  Heavy Load
- Height 1100, 1500, 2000, 2500, 3000 mm
- Standard Module 500 - 2000 mm (250 Increments)
- Corner External Available
- Fixing Included
- Colour

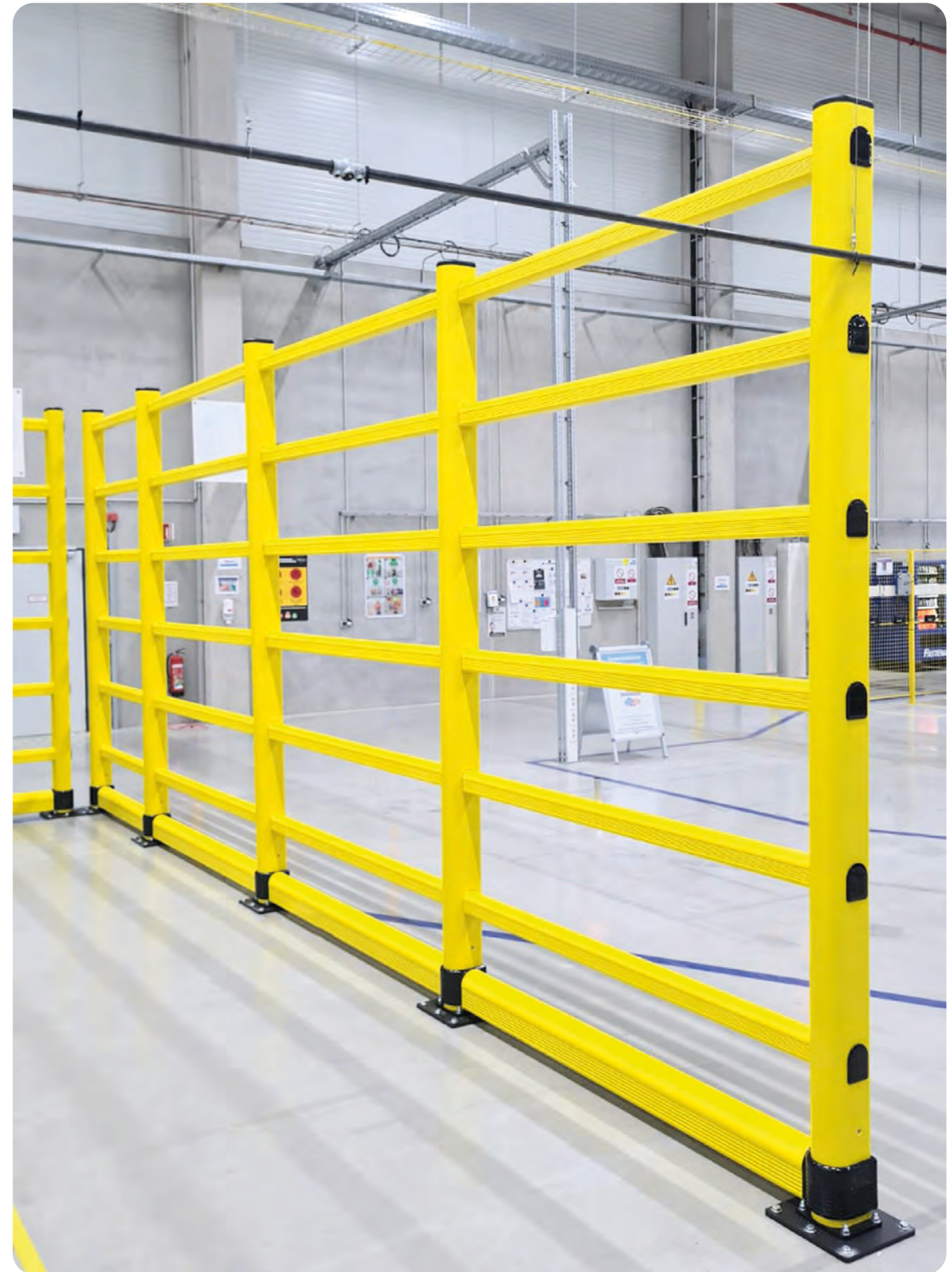

PIN



PED 150 PIN



PED 200 PIN



Heavy Load

Height **1100 mm**
 Standard Module **500 - 2500 mm (250 Increments)**
 Fixing **Included**
 Colour **● ●**



Heavy Load

Height **1100 mm**
 Standard Module **500 - 2000 mm (250 Increments)**
 Fixing **Included**
 Colour **●**

SHOCK ABSORBER PAD



INCLUDED



BFLEX MODULAR



SHOCK ABSORBER PAD

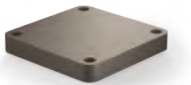

INCLUDED

BFLEX.FRONT/2 Modular



BFLEX.COM/2 Modular



Heavy Load

Height **1100 mm**
 Standard Module **750 - 2000 mm (250 increments)**
 Fixing **Included**
 Colour **●**



Heavy Load

Height **1100 mm**
 Standard Module **750 - 2000 mm (250 increments)**
 Corner **Available**
 Fixing **Included**
 Colour **●**





Safety Gate systems with different opening possibilities. Developed to complete our barriers for protection of pedestrian areas.

Sistema di cancelli di sicurezza ideati per completare le nostre barriere di protezione per aree pedonali.

Système de portillons étudié pour l'installation de nos barrières de protections pour les zones piétons.

Sistema de puertas diseñado para completar nuestras barreras peatonales.

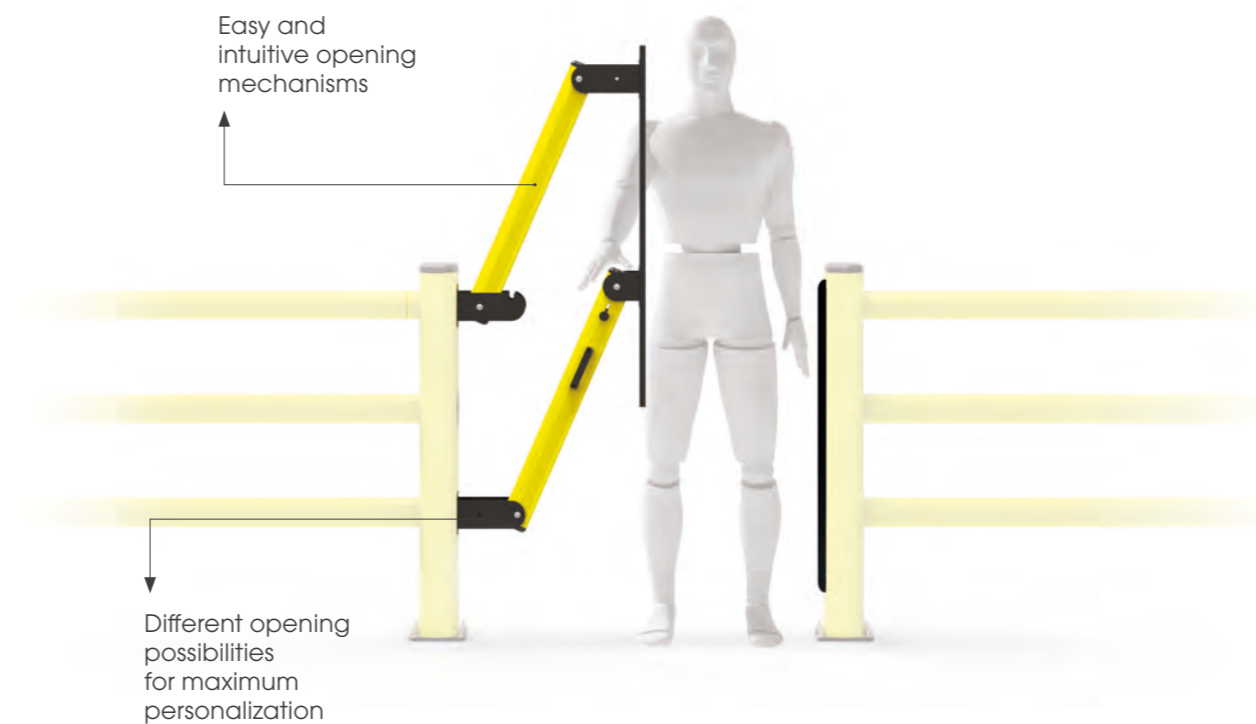

DOOR PEDESTRIAN 90

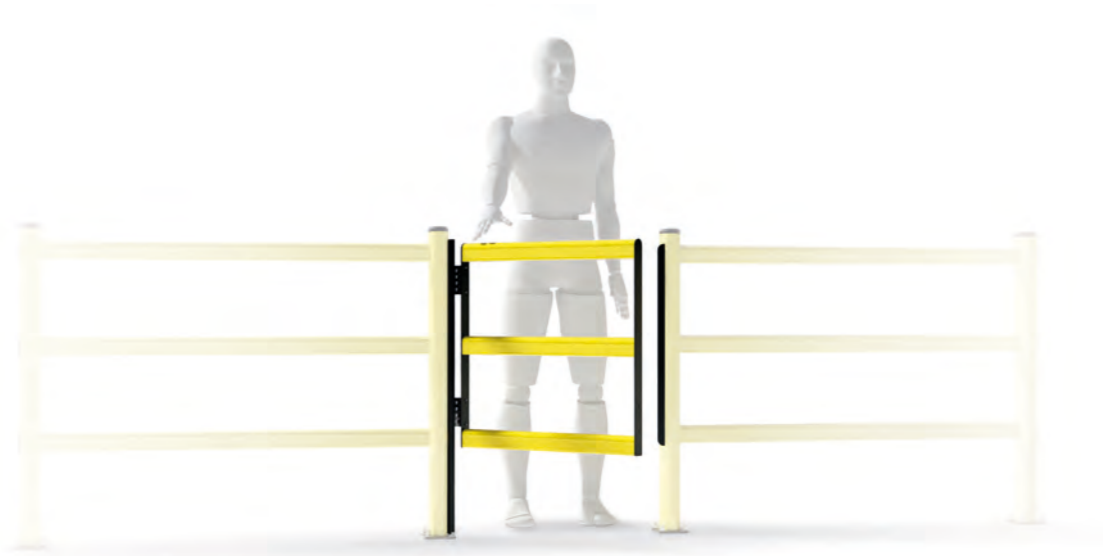

DP 90 ONE WAY

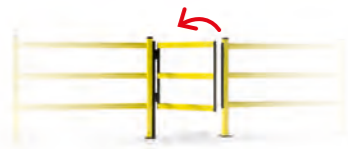

DP 90 SWING

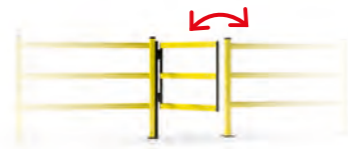

DP 90 SWING DOUBLE

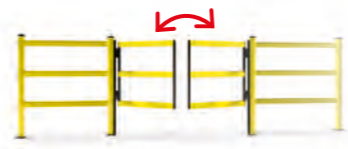

Width **Min 400 mm - Max 1000 mm (50 increments)**
 Fixing **Included**
 Colour **● ●**

Width **Min 400 mm - Max 1000 mm (50 increments)**
 Fixing **Included**
 Colour **● ●**

Width **Min 800 mm - Max 2000 mm (50 increments)**
 Fixing **Included**
 Colour **● ●**



LIFT GATE 90



LIFT GATE 90



LIFT GATE 90 DOUBLE



Width **Min 1050 mm - Max 1600 mm (50 increments)**
 Fixing **Included**
 Colour **● ●**

Width **Min 2100 mm - Max 3200 mm (50 increments)**
 Fixing **Included**
 Colour **● ●**



DOOR PEDESTRIAN 150

Discover our new tech **SAFE WAY** on page 94

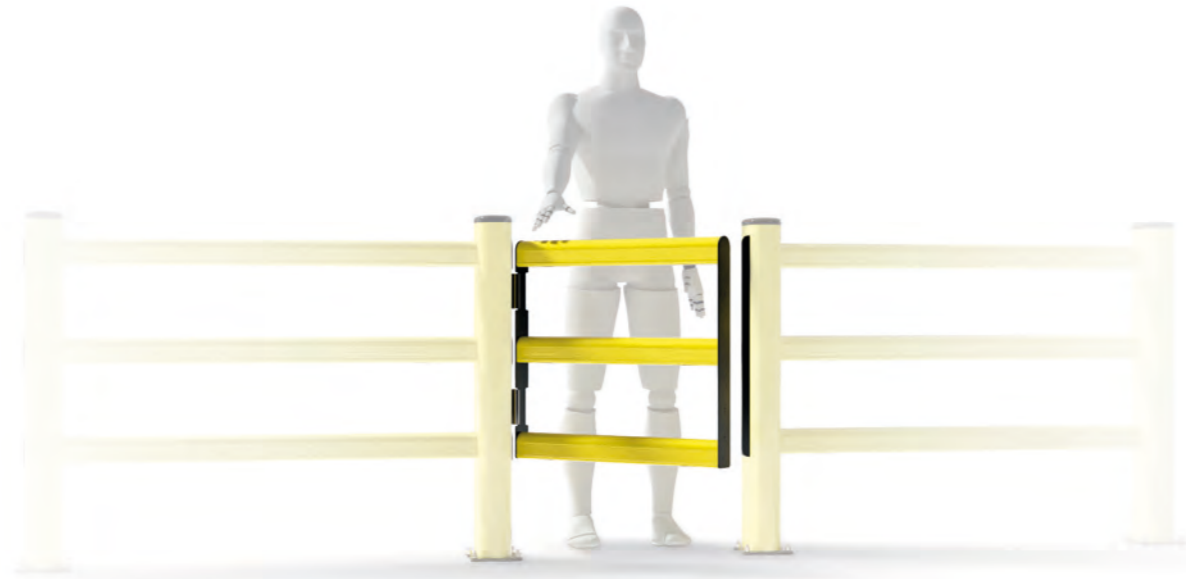

DP 150 ONE WAY

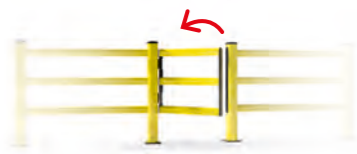

DP 150 SWING

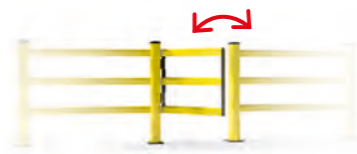

DP 150 SWING DOUBLE

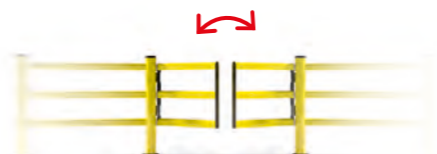

Width **Min 400 mm - Max 1000 mm (50 increments)**
 Fixing **Included**
 Colour **● ●**

Width **Min 400 mm - Max 1000 mm (50 increments)**
 Fixing **Included**
 Colour **● ●**

Width **Min 800 mm - Max 2000 mm (50 increments)**
 Fixing **Included**
 Colour **● ●**



LIFT GATE 150



LIFT GATE 150



LIFT GATE 150 DOUBLE

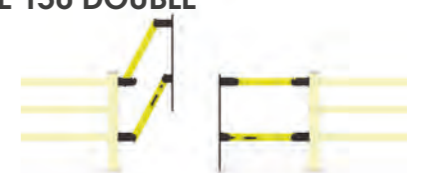

Width **Min 1100 mm - Max 2000 mm (50 increments)**
 Fixing **Included**
 Colour **● ●**

Width **Min 2200 mm - Max 4000 mm (50 increments)**
 Fixing **Included**
 Colour **● ●**



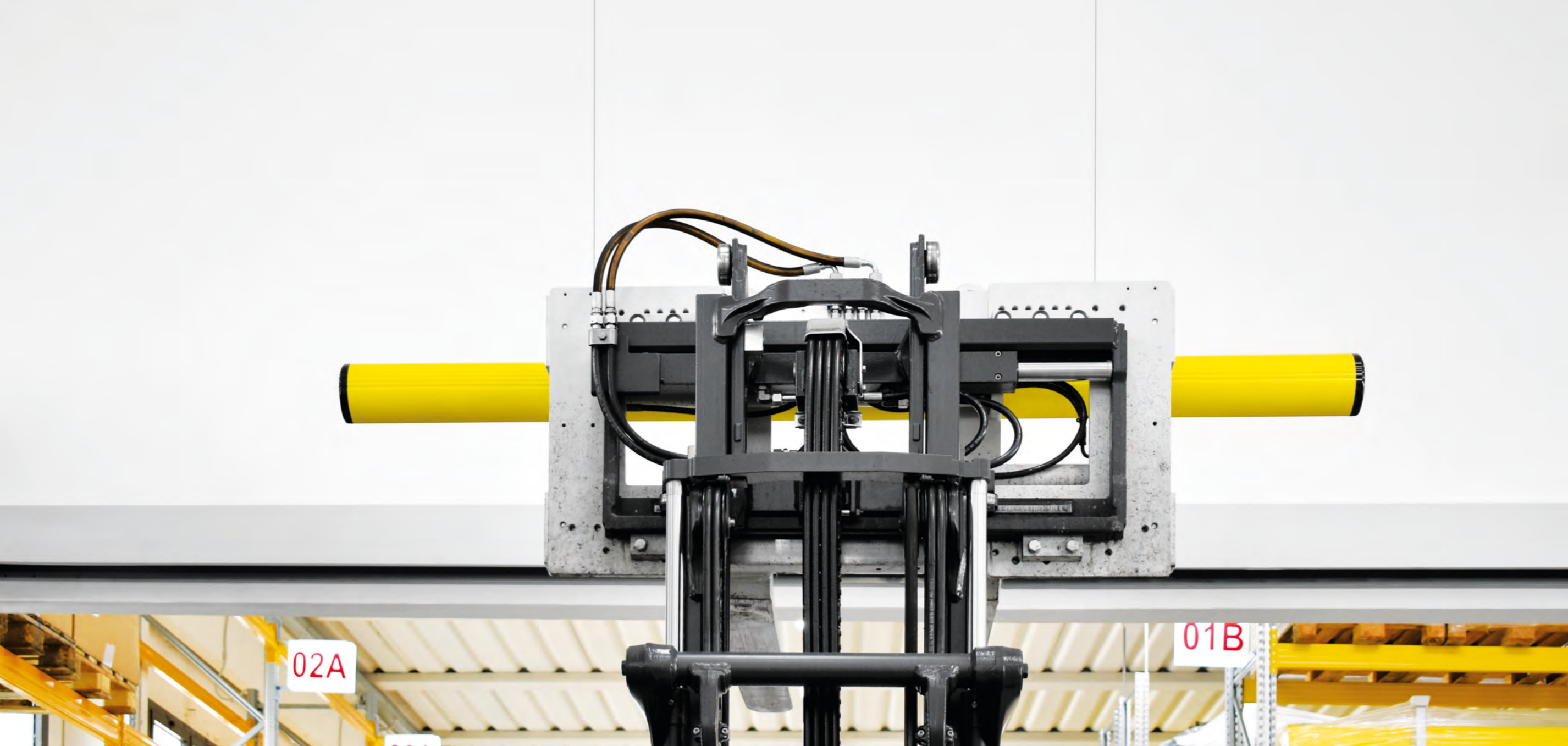

Protection system designed to prevent collisions with overhead infrastructure, gates and doors jambs. It is created to keep under control the passage of forklifts that exceed height limits.

Sistema di protezione ideato per prevenire le collisioni dei carrelli elevatori in movimento con le infrastrutture sopraelevate, gli stipiti di porte e portoni. Limita il passaggio di carrelli che superano i limiti di altezza.

Systèmes de protection conçus pour prévenir les collisions des chariots élévateurs en mouvement avec les infrastructures en hauteur et les montants des portes. Utiles pour empêcher le passage des chariots élévateurs qui dépassent les limites de hauteur.

Sistema de protección diseñado para evitar la colisión de carretillas elevadoras en movimiento con infraestructuras, instalaciones elevadas y marcos de puertas industriales. Diseñada para limitar el paso de las carretillas que superan los límites de altura.

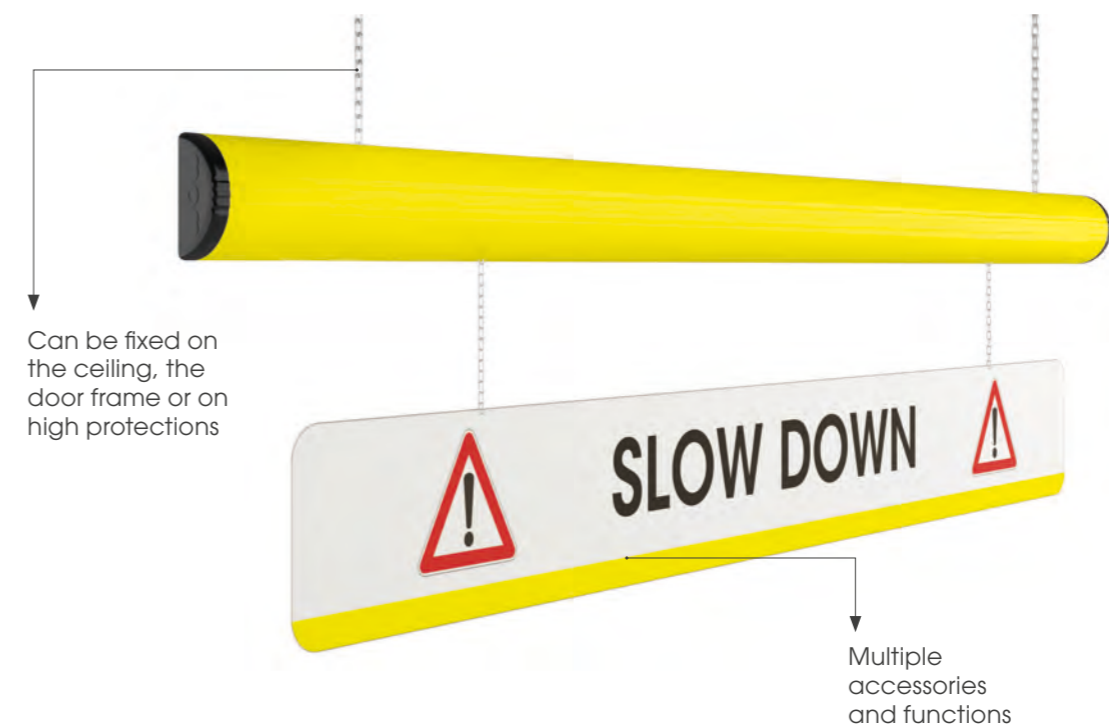

WARNING BAR

UP TO
70.000
IMPACTS!



WARNING BAR



Heavy Load
Length **2000, 3000 mm**
For Indoor Use Only
Colour **●**

WARNING BAR INFORMATION SIGN



Heavy Load
Length **2000, 3000 mm**
For Indoor Use Only
Colour **●**

WARNING BAR LIGHT & SOUND



Heavy Load
Length **2000, 3000 mm**
For Indoor Use Only
Colour **●**



FULL FRAME

INNOVATIVE
BIGGER PLATES!

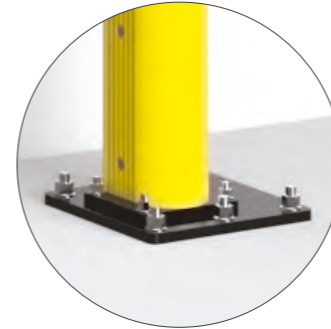

FOR SELF
STANDING



FULL FRAME SELF STANDING



Heavy Load
Height **UP to 5000 mm**
Width **UP to 4500 mm**
Fixing **Included**
Colour **●**

FULL FRAME WALL FIXING



Heavy Load
Height **To be defined**
Width **To be defined**
Fixing **Included**
Colour **●**





LOADING BAY PROTECTIONS

09

Impact protections designed for loading bays. They ensure safety for incoming vehicles and prevent damages.

Protezioni anti-urto progettate per le baie di carico. Garantiscono la sicurezza dei veicoli in arrivo e prevengono danni.

Protections contre les chocs conçues pour les quais de chargement. Elles garantissent la sécurité des véhicules entrants et préviennent les dommages.

Protecciones contra impactos diseñadas para muelles de carga. Aseguran la seguridad de los vehículos entrantes y previenen los daños.

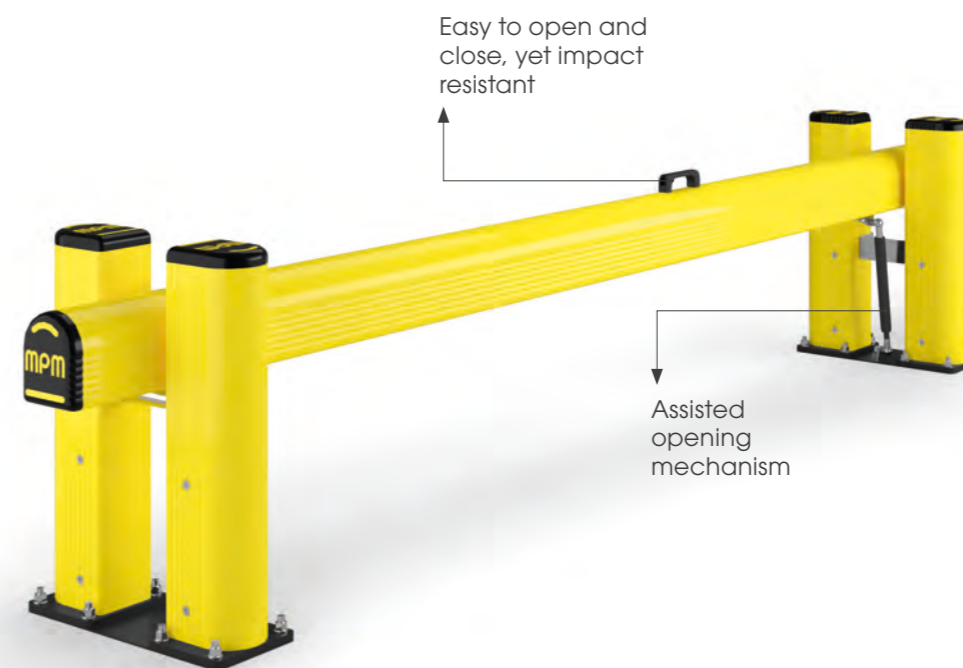

Easy to open and close, yet impact resistant

Assisted opening mechanism

DOCK GATE



HUG GATE



DOCK GATE



Light Load
 Height **1100 mm**
 Width **600 - 3000 mm (50 Increments)**
 Fixing **Included**
For Indoor Use Only
 Colour **●**

Heavy Load
 Height **640 mm**
 Width **L: 2400 - 2600 mm (50 Increments)**
XL: 2650 - 2800 mm (50 Increments)
XXL: 2850 - 3000 mm (50 Increments)
 Fixing **Included**
 Colour **● ●**



WHEEL STOP



CAR STOP



TRUCK STOP



Height **90 mm**
 Width **1810 mm**
 Fixing **On Request**

Height **150 mm**
 Width **1000 mm**
 Fixing **On Request**



DOCK BUMPER



DOCK BUMPER S



NEW

DOCK BUMPER



Height **400 mm**
 Width **110 mm**
 Fixing **On Request**
 Colour ●

Height **500 mm**
 Width **300 mm**
 Fixing **On Request**
 Colour ●



TRUCK LINE



TRUCK LINE



Heavy Load

Height **150 mm**
 Length **500, 750, 1000, 1250, 1500, 1750, 2000, 2250, 2500, 3000, 4000 mm**
 Fixing **Included**
 Colour ●●





COLUMN PROTECTIONS

10

Bumper system specific for columns protection, strongly resistant to impacts from moving vehicles of different loads.

Sistema di profili specifico per la protezione delle colonne dai carrelli in movimento di varie portate.

Nouveau système bumper, spécifique pour protéger les pouteaux contre les mouvements des chariots.

Sistema de perfiles específico para la protección de las columnas de los carros en movimiento de diferentes capacidades.

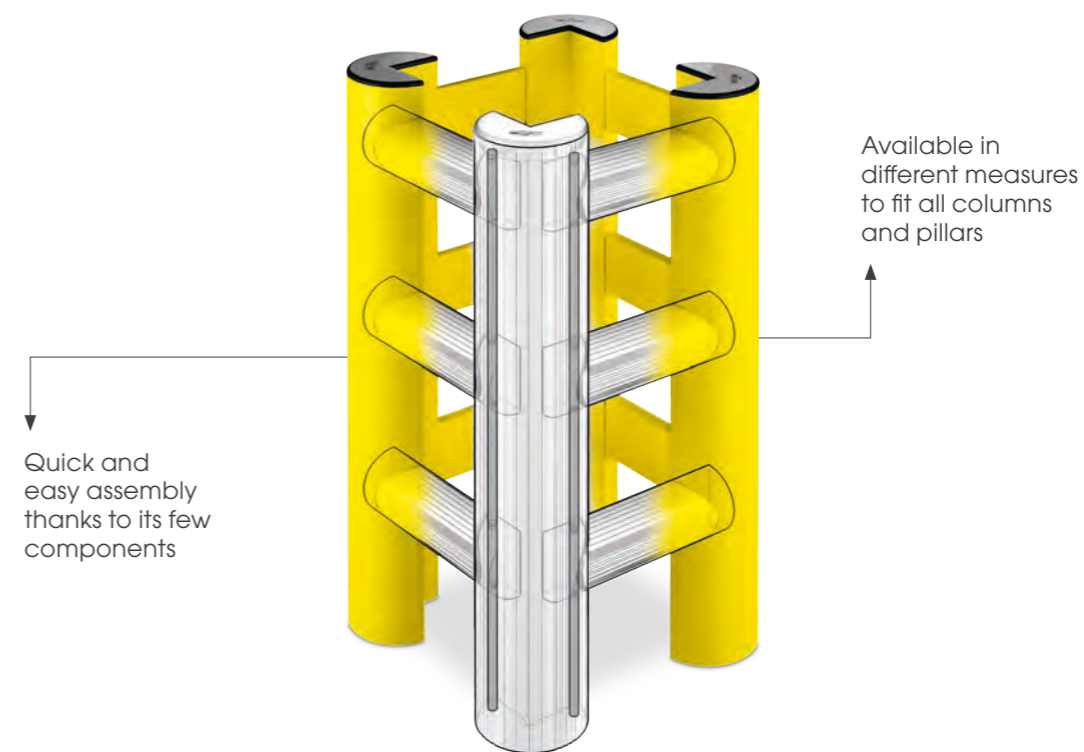

HUG TOWER

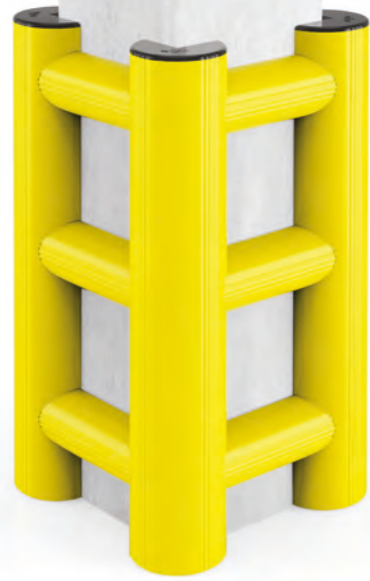

CHOOSE THE HEIGHT YOU NEED!

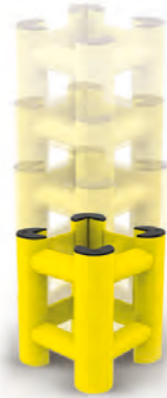

TOWER PROTECTION

AVAILABLE ALSO:

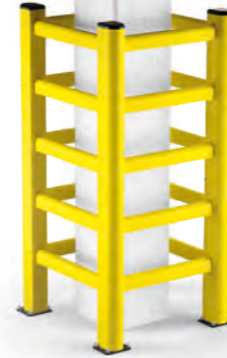

MINI HUG TOWER



HUG TOWER



TOWER PROTECTION



TOWER LINK 150/1



TOWER LINK 150/2



TOWER LINK 150/3



Heavy Load

Height **1100 mm**
 Fixing **Included**
 For Indoor Use Only
 Colour

Heavy Load

Height **730, 1090, 1450, 1810 mm**
 2/3 Sides **Available (1090 mm only)**
 Fixing **Included**
 For Indoor Use Only
 Colour

Heavy Load

Height **800, 1100, 1900 mm**
 2/3 Sides **Available (1100 mm only)**
 Fixing **Included**
 Colour

Heavy Load

Height **1100 mm**
 2/3 Sides **Available**
 Fixing **Included**
 Colour

Heavy Load

Height **1100 mm**
 2/3 Sides **Available**
 Fixing **Included**
 Colour

Heavy Load

Height **1150 mm**
 2/3 Sides **Available**
 Fixing **Included**
 Colour



COPRO

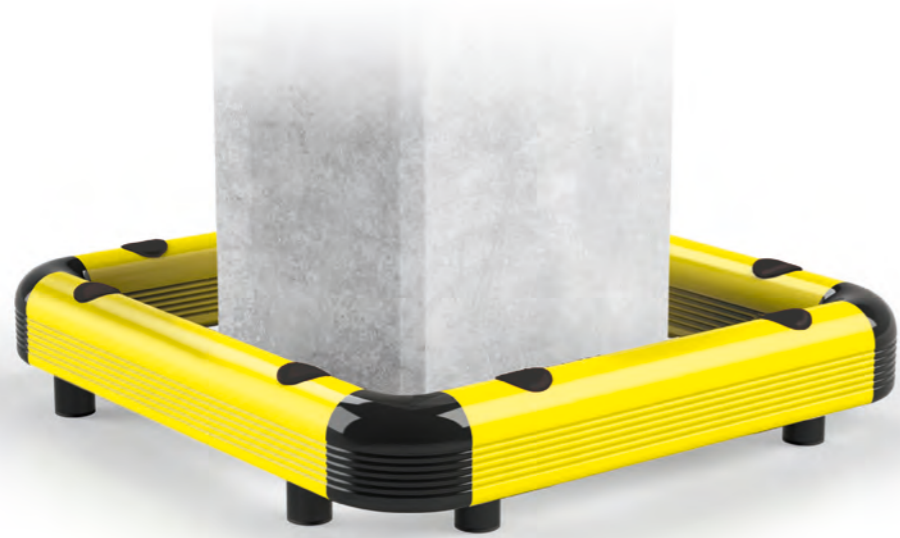

COPRO 90



COPRO 150

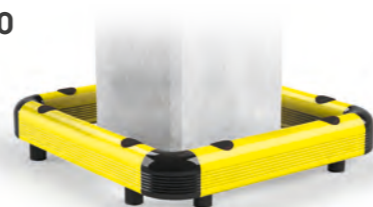

Light Load

Height **140 mm**
 2/3 Sides **Available**
 Fixing **Included**
 Colour **● ●**

Heavy Load

Height **200 mm**
 2/3 Sides **Available**
 Fixing **Included**
 Colour **● ●**



SOFT HUG

COMPACT & SOFT

VELCRO OPENING

SOFT HUG



Height **1800 mm**
 Width **80, 100, 150, 200, 250, 300, 400, 500, 600 mm**

For Indoor Use Only

Colour **●**

CHOOSE THE SIZE YOU NEED!

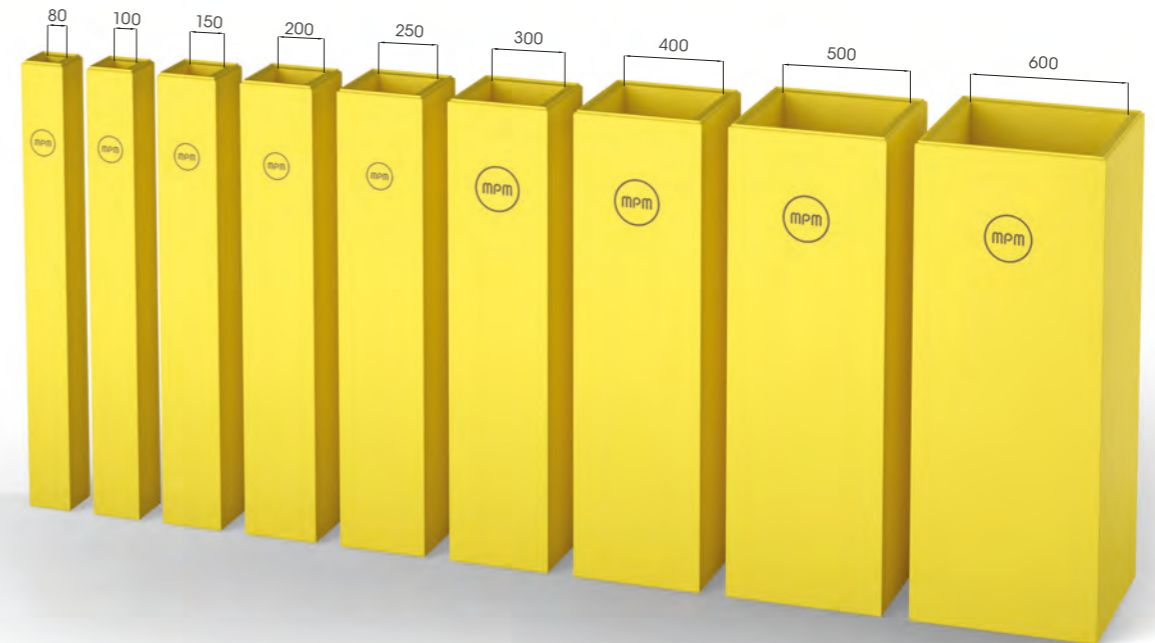



CORNER PROTECTIONS

11

Designed to protect pillars and columns or external corners of walls and panels.

Realizzato per proteggere pilastri e colonne o angoli esterni di muri e pannelli.

Étudié pour protéger les poteaux et les colonnes ou les angles extérieurs de murs et de panneaux.

Realizado para proteger pilares y columnas o esquinas exteriores de paredes y paneles.

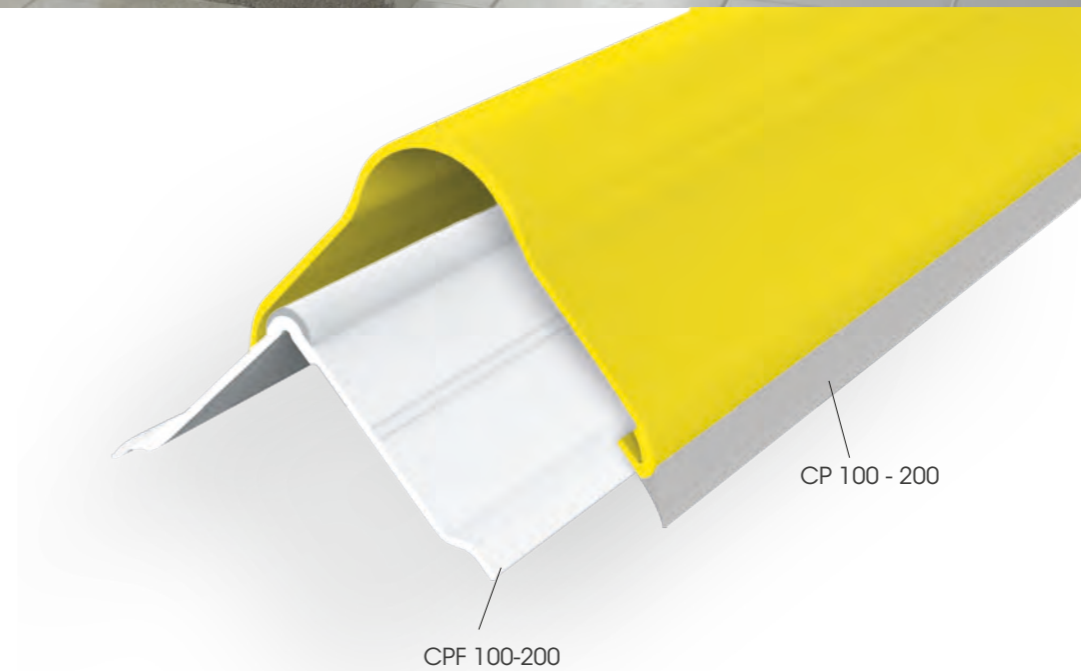

CP

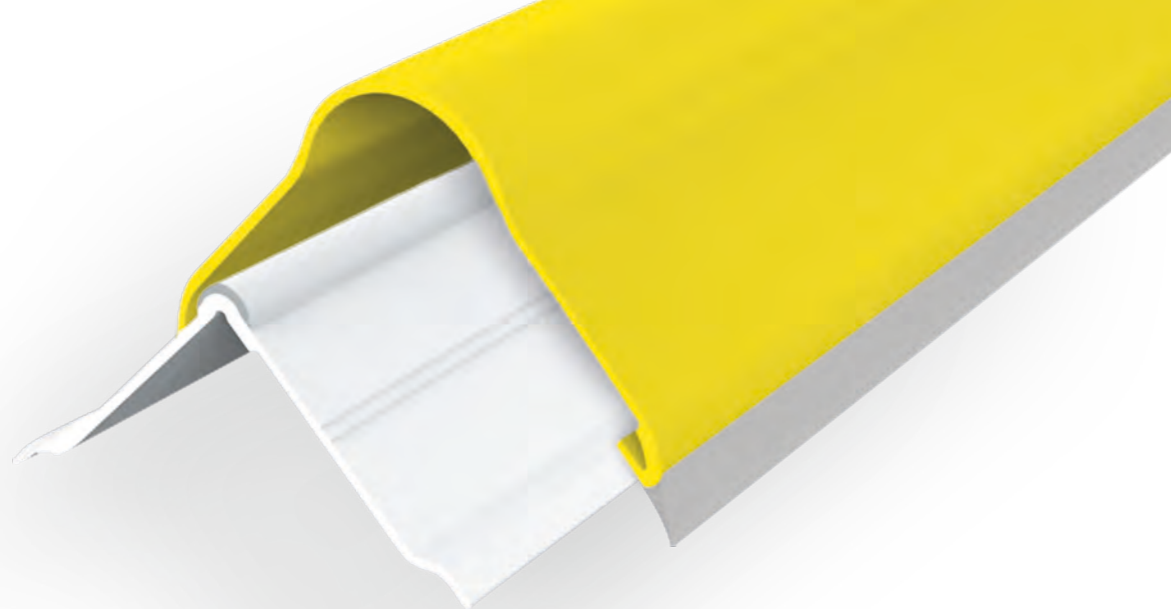

 <p>CP 100</p>	<p>Length 4.000 mm Packing 10 pcs / box Colour M B E F</p> <p>Length 2.000 mm Packing 10 pcs / bag Colour M</p>	 <p>CP 200</p>	<p>Length 4.000 mm Packing 2 pcs / bag Colour M B E</p> <p>Length 2.000 mm Packing 2 pcs / bag Colour M</p>
 <p>CPF 100</p>	<p>Length 4.000 mm Packing 10 pcs / box</p> <p>Length 2.000 mm Packing 10 pcs / bag</p>	 <p>CPF 200</p>	<p>Length 2.000, 4.000 mm Packing 2 pcs / bag</p>
 <p>CPT 100</p>	<p>Packing 40 pcs / box Colour B E F</p>	 <p>CPT 200</p>	<p>Packing 20 pcs / box Colour B E</p>



FLEXI LINE

DOUBLE-SIDED TAPE FIXING

SOFT IMPACT

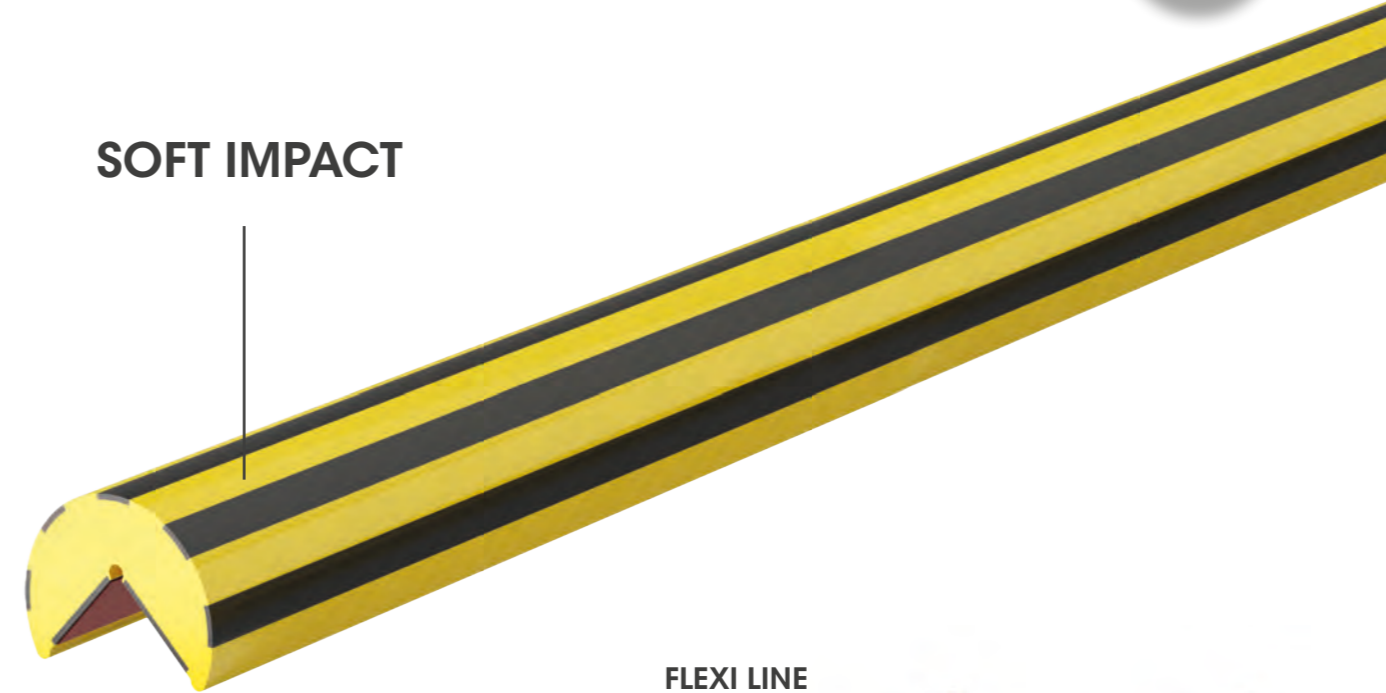

FLEXI LINE



Length **1.000, 3.000 mm**
 Diameter **Ø 39 mm**
 Colour **Yellow/Black, Red/White**





Innovative protections systems for walls and panels.
Easy to install and clean. Fully equipped with corner caps and buttons.

Sistemi innovativi di protezione per pareti e pannelli.
Facile da installare e pulire. Completo di angolari e tappi.

Systèmes de protection innovants pour les murs et les panneaux.
Facile à installer et à nettoyer. Complété de bouchons d'angles et d'embouts.

Sistemas de protección innovadores para paredes y paneles.
Fácil de instalar y limpiar. Completo de esquinas y tapas.

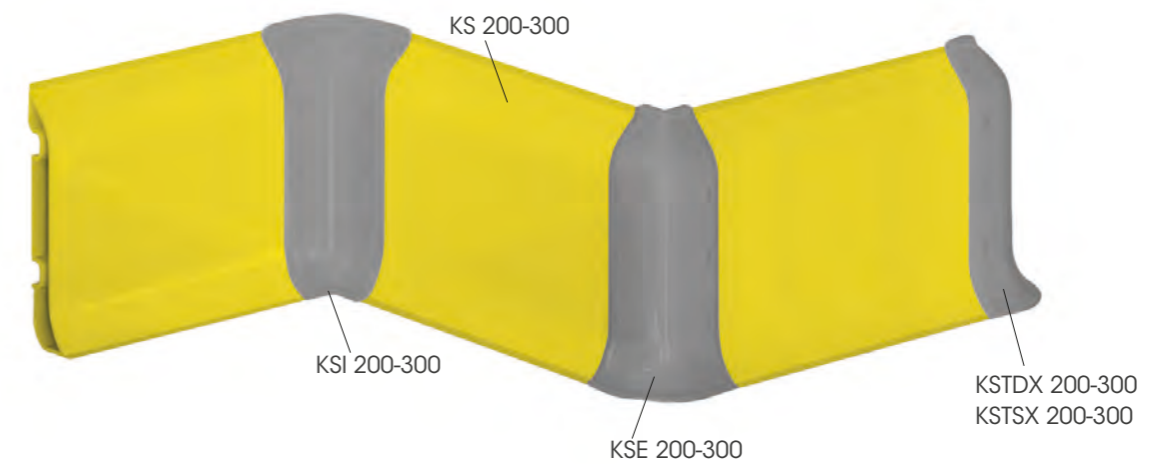

PLEX

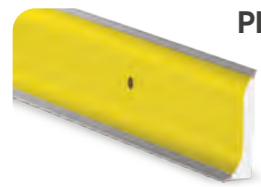
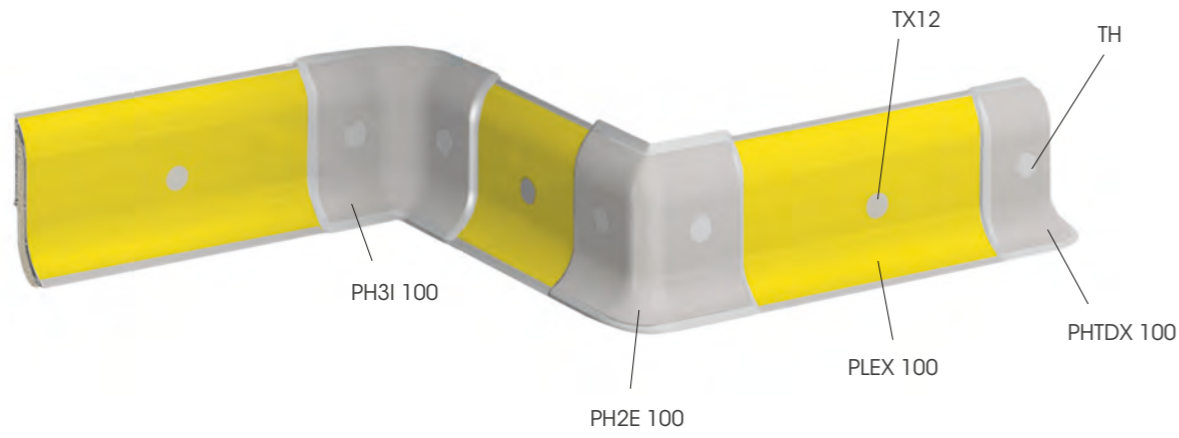

PLEX 100

Height **100 mm**
 Length **4.000 mm**
 Packing **8 pcs / box**
 To be complete with TX12
 Colour **M K**



PH2E 100

Height **100 mm**
 Packing **50 pcs / box**
 To be complete with TH
 Colour **K**



PH2I 100

Height **100 mm**
 Packing **50 pcs / box**
 To be complete with TH
 Colour **K**



PH3I 100

Height **100 mm**
 Packing **50 pcs / box**
 To be complete with TH
 Colour **K**



PHJ 100

Height **100 mm**
 Packing **100 pcs / box**
 To be complete with TH
 Colour **F K**



PHTDX/SX 100

Height **100 mm**
 Packing **100 pcs / box**
 To be complete with TH
 Colour **K**



KERB

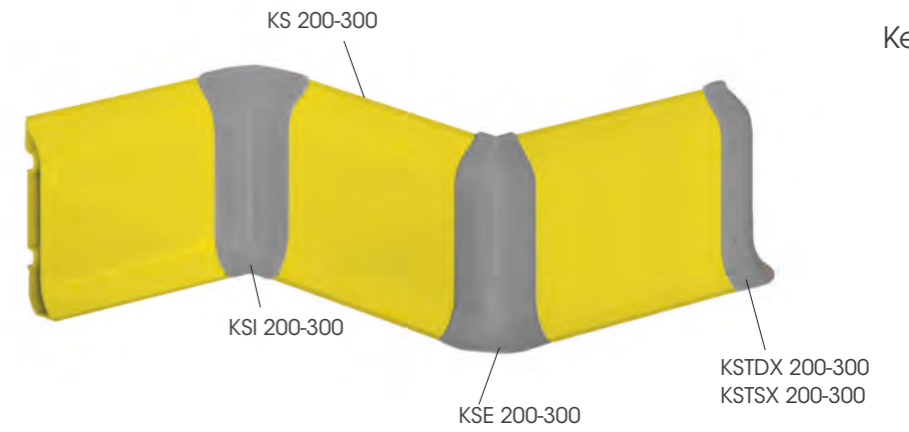

KS 200

Height **200 mm**
 Length **4.000 mm**
 Depth **54 mm**
 Packing **3 pcs / box**
 Colour **M B E**



KS 300

Height **300 mm**
 Length **4.000 mm**
 Depth **77 mm**
 Packing **1 pcs**
 Colour **M E**

KEPF 200/300



Height **170 mm (200)**
255 mm (300)
 Packing **50 pcs / box (200)**
20 pcs / box (300)
 Colour **K**

KSE 200/300



Height **200 mm**
300 mm
 Packing **20 pcs / box (200)**
10 pcs / box (300)
 Colour **B E**

KSJ 200/300



Height **200 mm**
300 mm
 Packing **20 pcs / box (200)**
10 pcs / box (300)
 Colour **B E**

KSTDX/SX 200/300



Height **200 mm**
300 mm
 Packing **20 pcs / box (200)**
10 pcs / box (300)
 Colour **B E**

KSI 200/300



Height **200 mm**
300 mm
 Packing **20 pcs / box (200)**
10 pcs / box (300)
 Colour **B E**

KSJ 200 LT



Height **200 mm**
 Packing **20 pcs / box**
 Colour **K**

FOR LOW TEMPERATURES





Solutions designed to protect walls in all industrial spaces. Available with fixed caps with hidden fixings to ensure high hygiene.

Soluzioni progettate per proteggere le pareti in tutti gli spazi industriali. Disponibili con tappi fissi e fissaggi nascosti per garantire un'igiene elevata.

Solutions conçues pour protéger les murs dans tous les espaces industriels. Disponibles avec des bouchons fixes et des fixations cachées pour assurer une hygiène élevée.

Soluciones diseñadas para proteger paredes en todos los espacios industriales. Disponibles con tapas fijas y fijaciones ocultas para garantizar una alta higiene.

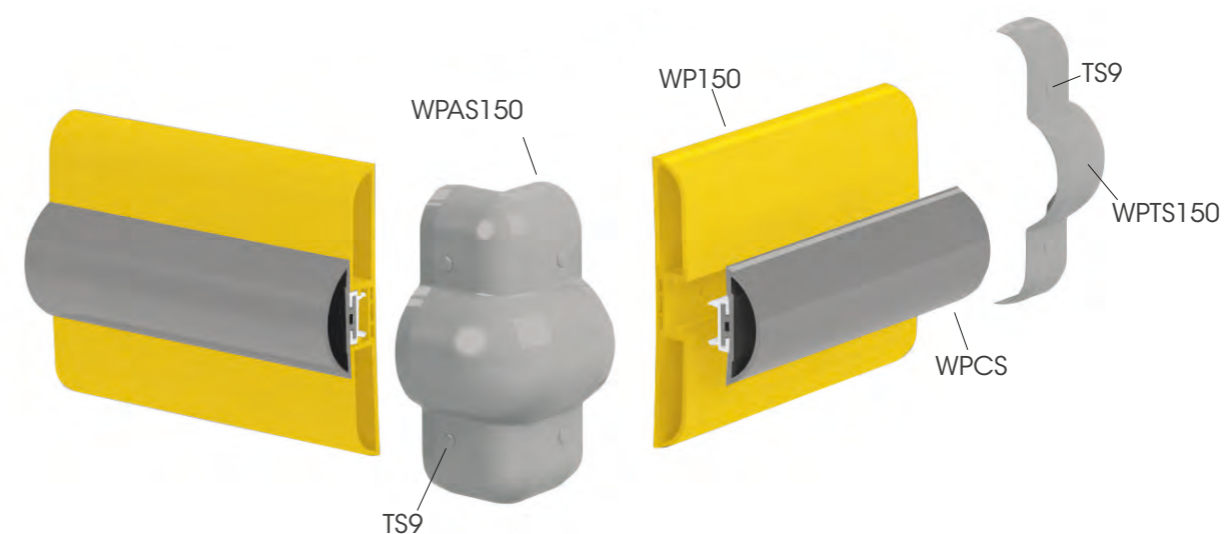

WP

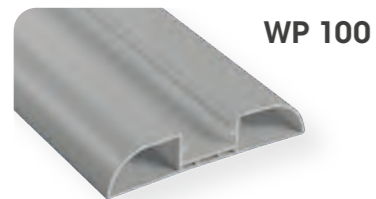
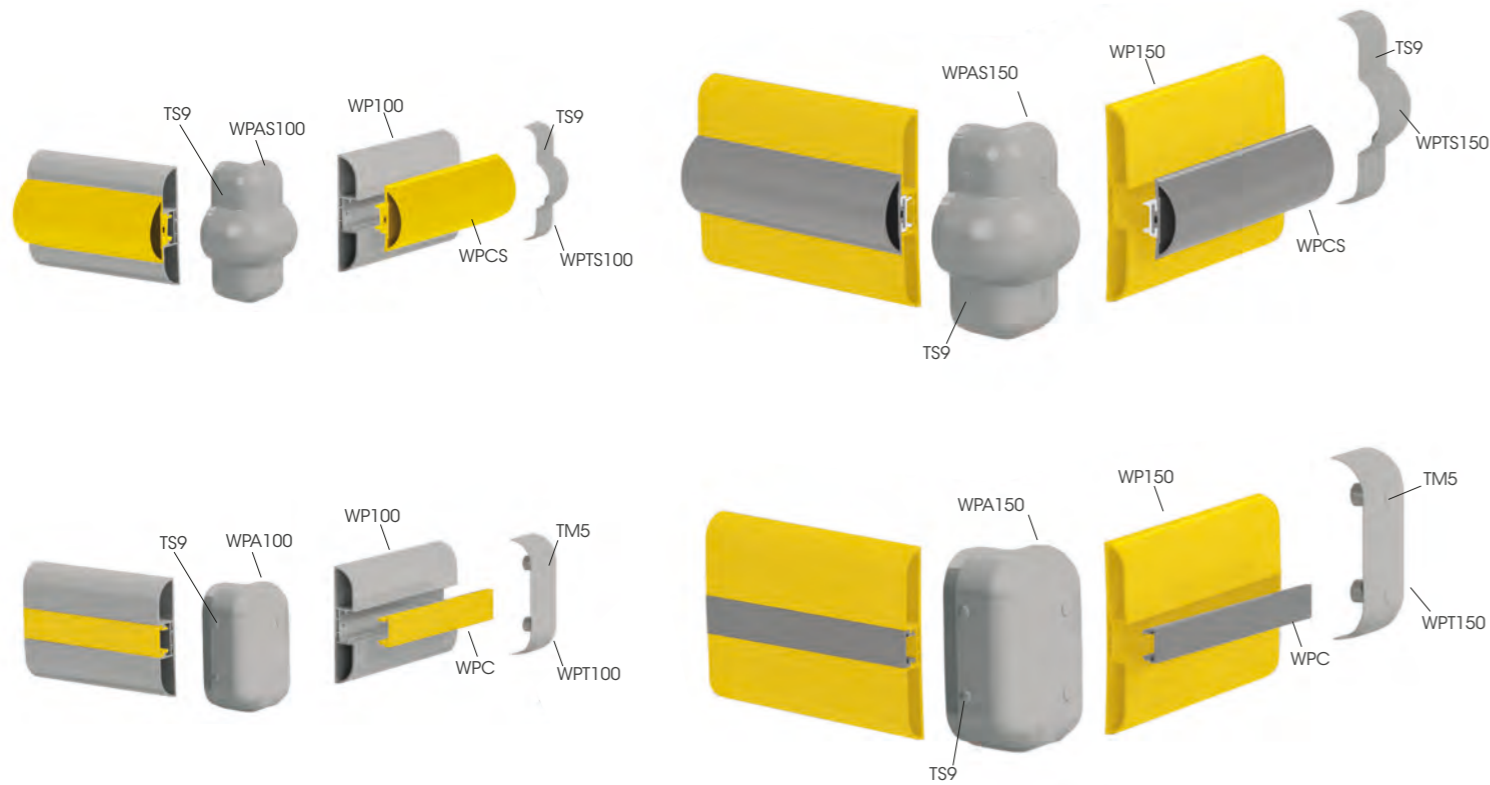

WP 100

Length **4.000 mm**
 Height **100 mm**
 Depth **21 mm**
 Packing **8 pcs / box**
 Colour **B E F**

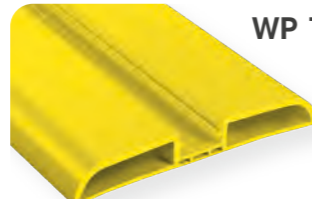

WP 150

Length **4.000 mm**
 Height **150 mm**
 Depth **21 mm**
 Packing **4 pcs / box**
 Colour **M B E**



WPC

Length **4.000 mm**
 Height **27 mm**
 Depth **13 mm**
 Packing **16 pcs / box**
 Colour **A B M D E F G H**

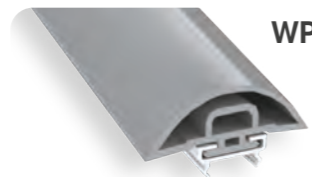

WPCS

Length **4.000 mm**
 Height **62 mm**
 Depth **22 mm**
 Packing **8 pcs / box**
 Colour **A B M D E F G H I**



WPT 100/150

Height **100, 150 mm**
 Width **22, 52 mm**
 Packing **50 pcs / box**
To be completed with TM5
 Colour **B E**



WPTS 100/150

Height **100, 150 mm**
 Packing **20 pcs / box**
To be completed with TS9
 Colour **B E**

WPA 100/150



Height **100, 150 mm**
 Packing **20 pcs / box**
To be completed with TM5
 Colour **B E**

WPAS 100/150



Height **100, 150 mm**
 Packing **20 pcs / box**
To be completed with TS9
 Colour **B E**

ASP

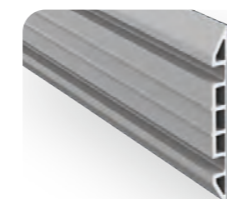
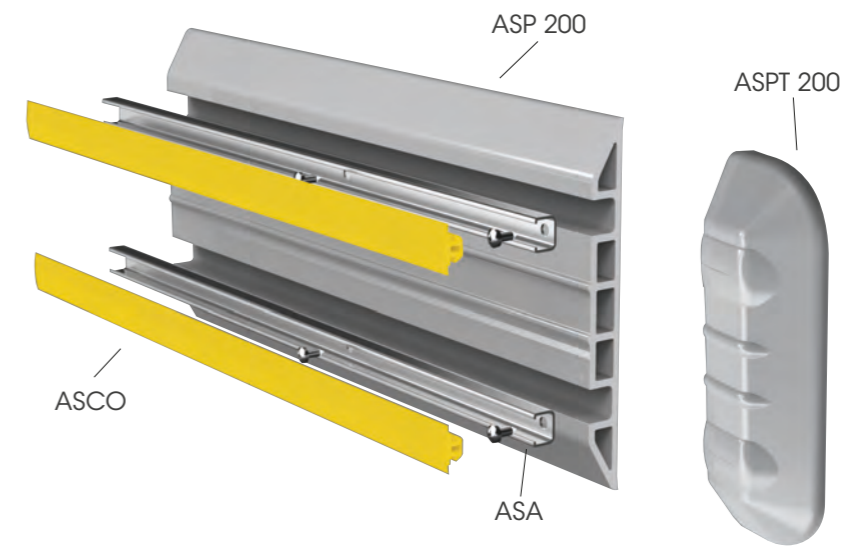

ASP 200

Length **4.000 mm**
 Height **200 mm**
 Depth **20 mm**
 Packing **2 pcs / box**
 Colour **M B**

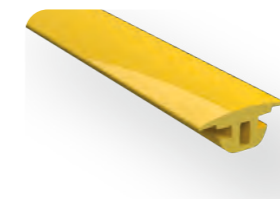

ASCO

Length **32.000 mm**
 Height **25 mm**
 Packing **2 pcs / box**
 Colour **A B M D G**

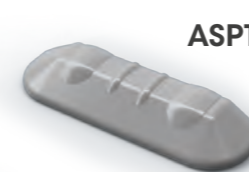

ASPT 200

Height **200 mm**
 Packing **10 pcs / box**
 Colour **B D**

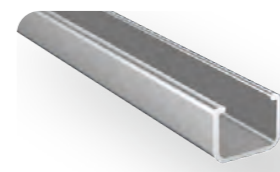

ASA

Material **Aluminium**
 Length **4.000 mm**
 Height **13,5 mm**
 Width **18 mm**
 Packing **8 pcs / bundle**



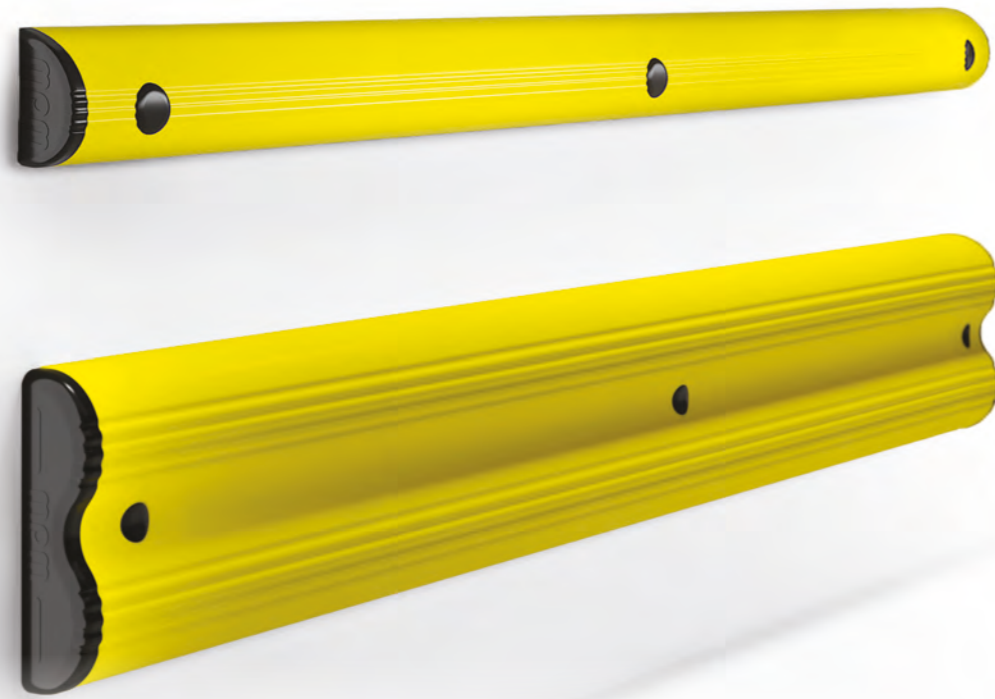

WALL HUG



For Indoor Use Only

Light Load
 Length **1,000, 2,000, 3,000, 4,000 mm**
 Height **130 mm**
 Depth **70 mm**
 Fixing **Not included**
 Colour **Yellow**

WALL BFLEX



Light Load
 Length **1,000, 2,000, 3,000, 4,000 mm**
 Height **300 mm**
 Depth **80 mm**
 Fixing **Not included**
 Colour **Yellow**

WALL BFLEX MODULAR



Light Load
 Height **300 mm**
 Depth **80 mm**
 Standard Module **1000 - 2000mm (250 Increments)**
 Fixing **Not included**
 Colour **Yellow**





MPM accessories are designed to create a safe working environment.

Gli accessori MPM sono ideati per creare un ambiente di lavoro sicuro.

Les accessoires MPM sont conçus pour créer un environnement de travail sûr.

Los accesorios MPM están diseñados para crear un entorno de trabajo seguro.



VISIBOARD



VISIBOARD



Sign Ø 200 mm
Width 240 mm

VISIPOLE



 Heavy Load
Height 1500 mm
Colour ● ●



SOFT BOLLARD



SOFT BOLLARD



Height 770 mm
Fixing On Request
Colour ● ● ●



REMOVABLE PLATE

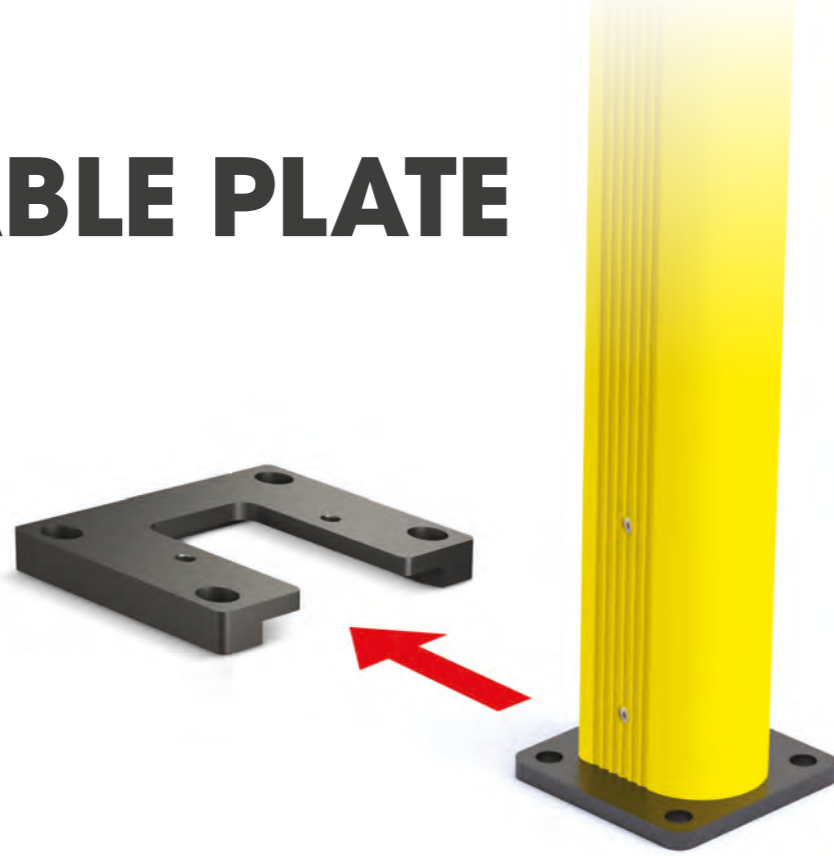

KIT 90 RE COVER



Height **22 mm**
 Width **182 mm**
 Depth **136 mm**
 Available For: **SM / FENCE 90 / HR / PED 90 / GRD 90 / LINK 120**

KIT 150 RE COVER



Height **24 mm**
 Width **242 mm**
 Depth **176 mm**
 Available For: **LM / FENCE 150 / PED 150 / GRD 150 / LINK 150**

CABLE COVER

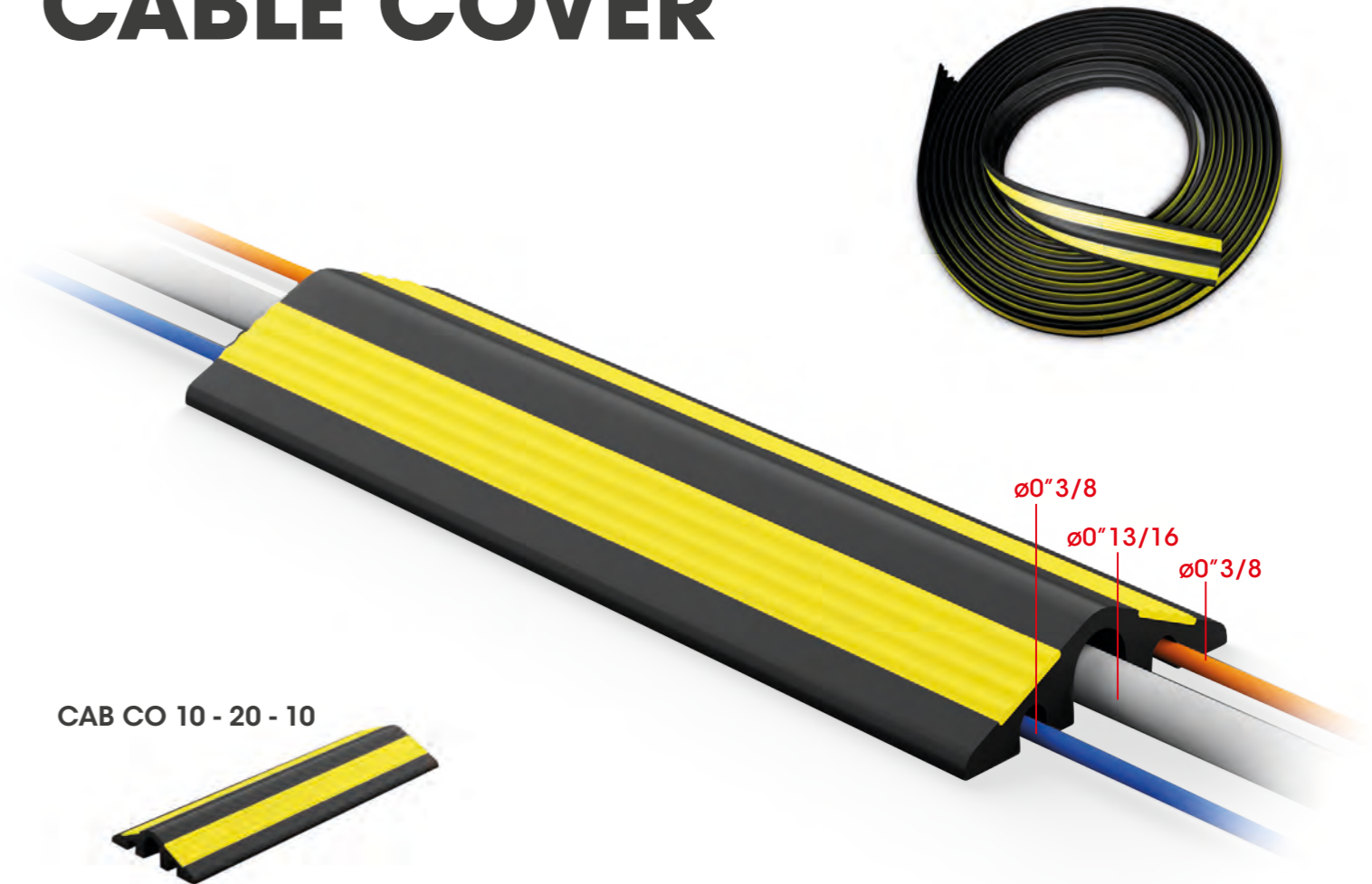

CAB CO 10 - 20 - 10



Length **1.000, 3.000, 10.000 mm**
 Packing **8 pcs / box (1.000/3.000 mm)**
1 pcs / box (10.000 mm)



GENIUS

THE LENGTH THAT YOU WISH

CUT THE RAIL AND DRILL IT

Do you need to modify the length of your protections?

With our innovative Genius system, you can customize your barriers according to your needs.

Vuoi modificare la lunghezza delle tue protezioni?

Con il nostro innovativo sistema Genius potrai personalizzare le tue barriere, in base alle tue esigenze.

Besoin de modifier la longueur de vos protections?

Avec notre système innovant Genius, vous pouvez personnaliser vos barrières selon vos besoins.

¿Necesitas modificar la longitud de tus protecciones?

Con nuestro innovador sistema Genius, puedes personalizar tus barreras según tus necesidades.

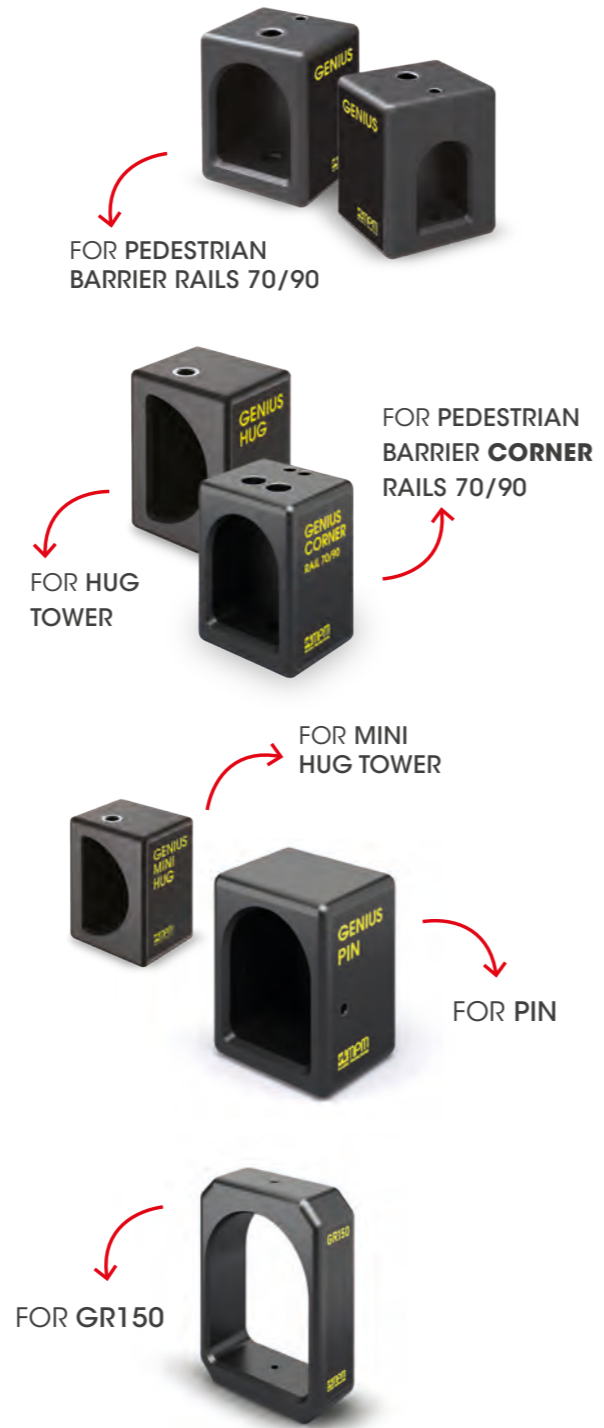

CLIP 90

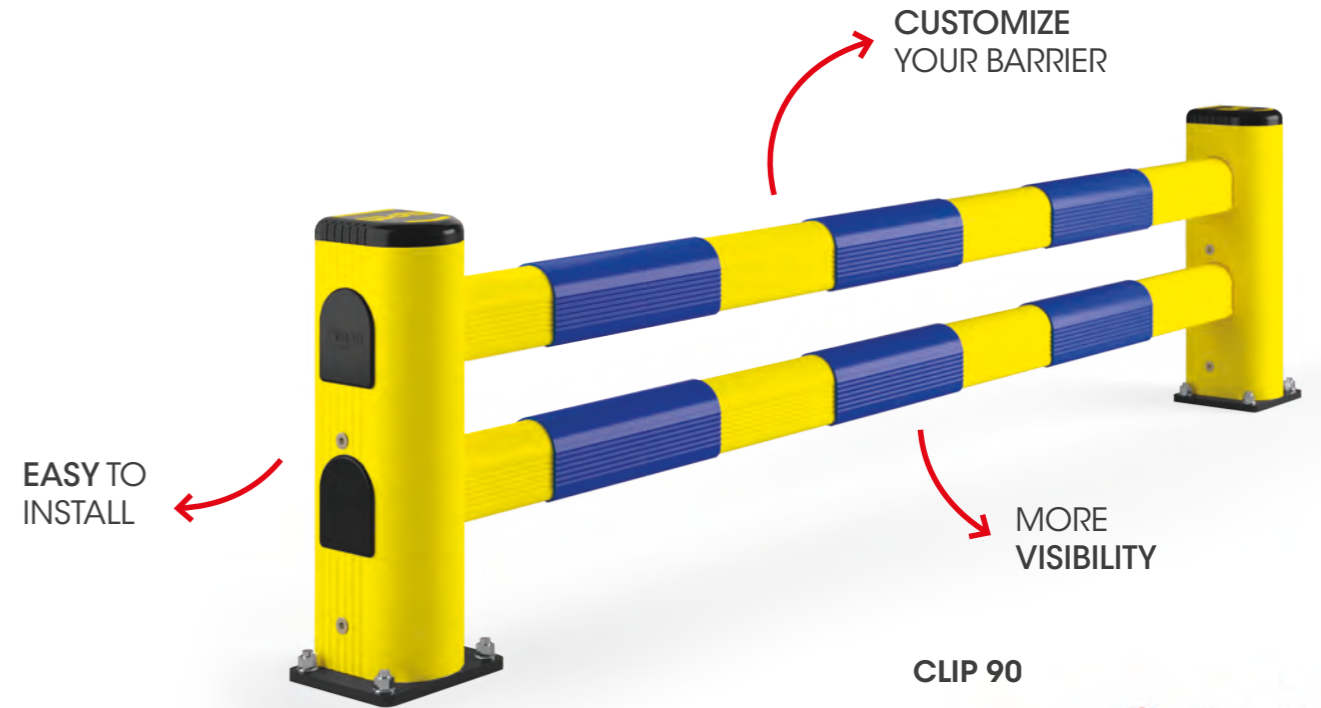

CLIP 90

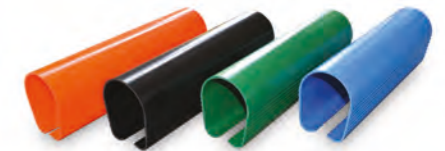

Length 300 mm
 Suitable LM, PED 150, TOWER PROTECTIONS, DP 150, SWING GATE
 For Indoor Use Only
 Colour ●●●●



WORLD'S UNIQUE SYSTEM!

YOUR CUSTOMIZED BARRIER





Innovation never stops.
Our R&D department has been working on new solutions that will greatly aid you in the creation of a safer warehouse. Smart solutions are the future of safety!

L'innovazione non si ferma mai.
Il nostro reparto Ricerca e Sviluppo sta lavorando su nuove soluzioni che vi aiuteranno notevolmente nella creazione di un magazzino più sicuro. Le soluzioni intelligenti sono il futuro della sicurezza!

L'innovation ne s'arrête jamais.
Notre département R&D travaille sur de nouvelles solutions qui vous aideront grandement dans la création d'un entrepôt plus sûr. Les solutions intelligentes sont l'avenir de la sécurité!

La innovación nunca se detiene.
Nuestro departamento de I+D ha estado trabajando en nuevas soluciones que te serán de gran ayuda en la creación de un almacén más seguro. ¡Las soluciones inteligentes son el futuro de la seguridad!



Sensors capable of detecting incoming traffic

Simple and very efficient system to avoid collisions

SHUTTLE

**DUAL
SENSOR**



SHUTTLE



Height **200 mm**
 Width **236,5 mm**
 Depth **128,5 mm**
 Range detection **7.000 - 8.000 mm**
 For Indoor Use Only
 Colour **Yellow**

 **Piezoelectric BUZZER**

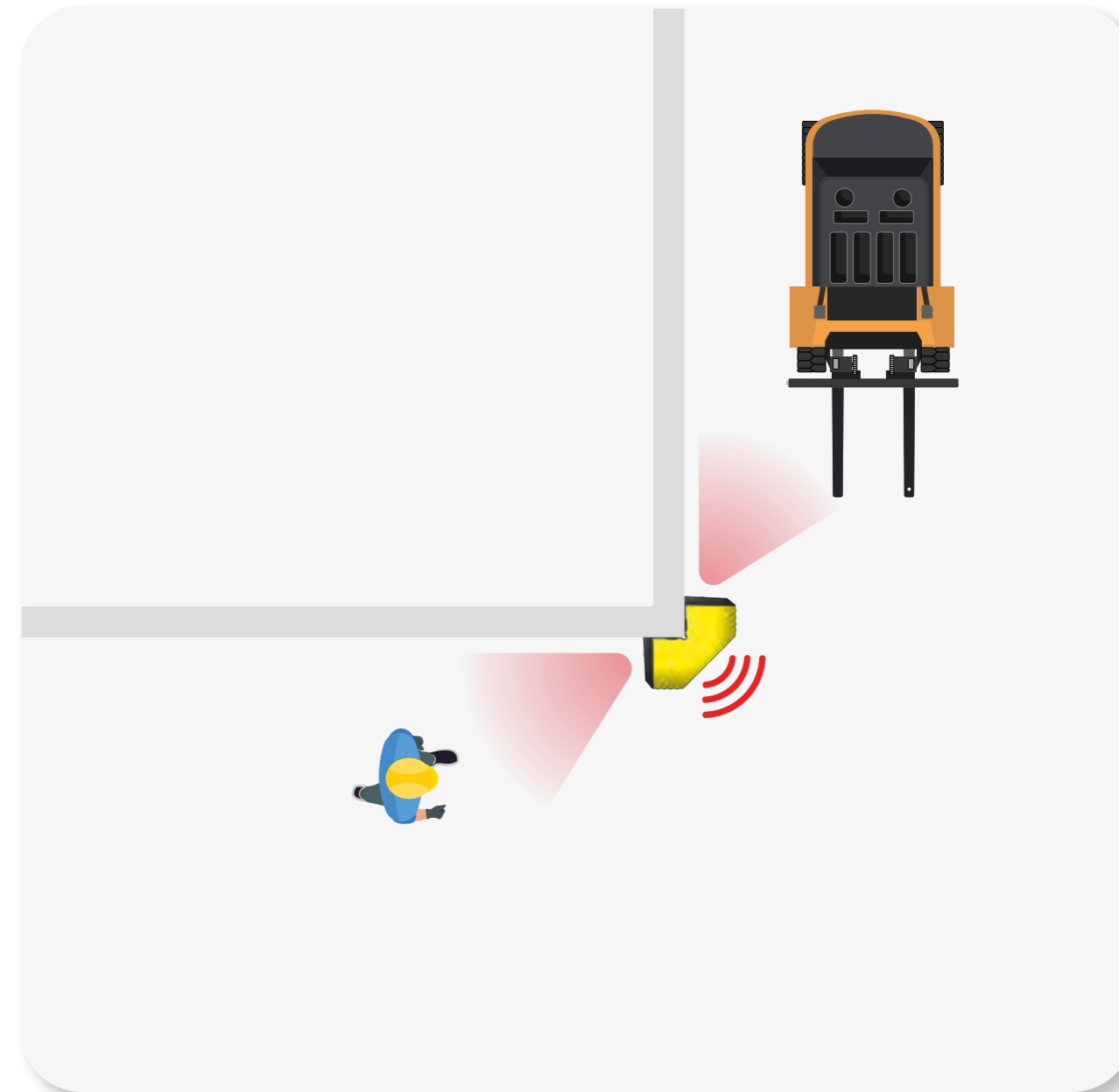

Our SHUTTLE can warn you of Possible collisions around corners. It can detect incoming traffic from both ends and, if a collision is possible, will warn you with audio and visual cues. It can spot all types of moving object, from the largest to the smallest.

Il nostro SHUTTLE può avvisarti di possibili collisioni intorno agli angoli. Può rilevare il traffico in arrivo da entrambe le direzioni e, se c'è la probabilità di una collisione, ti avviserà con segnali acustici e visivi. Può individuare tutti i tipi di oggetti in movimento, dai più grandi ai più piccoli.

Notre SHUTTLE peut vous avertir des collisions possibles autour des coins. Il peut détecter la circulation entrante des deux côtés et, en cas de risque de collision, vous avertira par des signaux audio et visuels. Il peut repérer tous les types d'objets en mouvement, du plus grand au plus petit.

Nuestro SHUTTLE puede advertirte de posibles colisiones alrededor de las esquinas. Puede detectar el tráfico entrante desde ambos extremos y, si es posible una colisión, te advertirá con señales auditivas y visuales. Puede identificar todo tipo de objetos en movimiento, desde los más grandes hasta los más pequeños.

SAFE WAY



DP 150 SAFE WAY

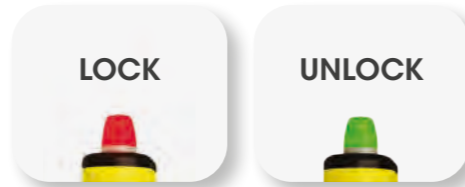

- Width **Min 400 mm - Max 1.000 mm (50 increments)**
- Fixing **Included**
- Colour



SAFE WAY IS THE RIGHT WAY

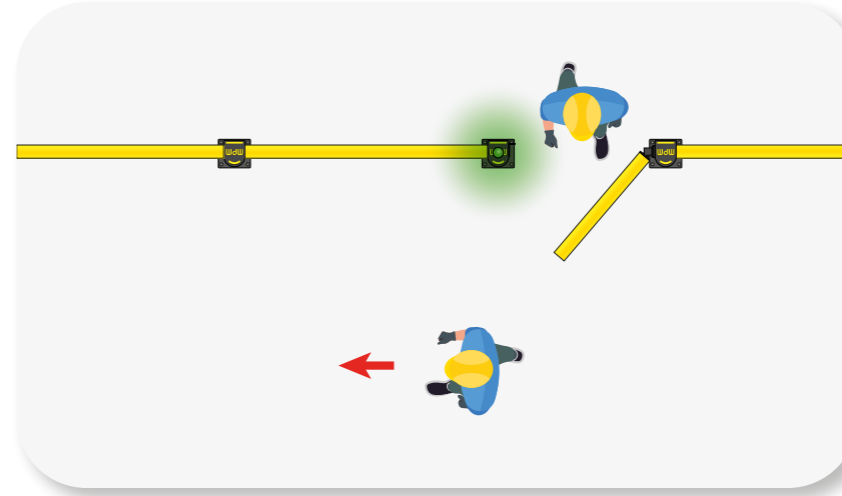

Safe Way determines if the crossing is safe and distinguishes vehicles from pedestrians.

Safe Way determina se l'attraversamento è sicuro e distingue i veicoli dai pedoni

Safe Way détermine si la traversée est sécurisée et distingue les véhicules des piétons.

Safe Way determina si el cruce es seguro y distingue los vehículos de los peatones.

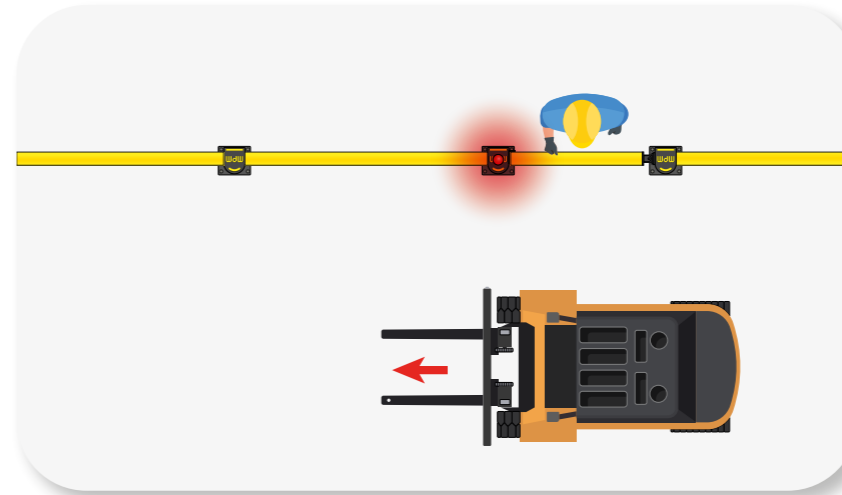

It stops when it detects oncoming vehicular traffic.

Si blocca quando rileva traffico veicolare in arrivo.

Il s'arrête lorsqu'il détecte la circulation automobile arrivante.

Se detiene cuando detecta tráfico vehicular entrante.

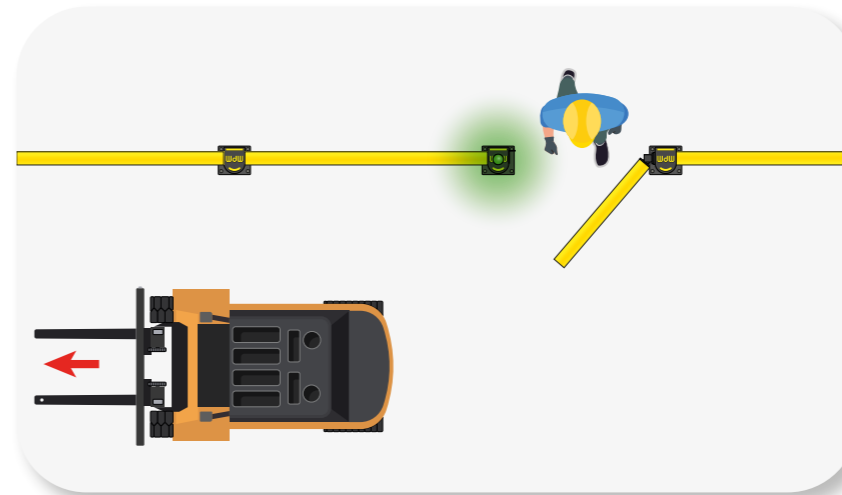

Safe Way allows passage when the vehicle no longer poses a danger.

Safe Way consente il passaggio quando il veicolo non rappresenta più un pericolo

Safe Way permet le passage lorsque le véhicule ne représente plus un danger.

Safe Way permite el paso cuando el vehículo ya no representa un peligro.

Fixing accessories



S12 - S16 - S20
HILTI
Hole required \varnothing 10-14-16
Galvanized steel.



M12 - M16
HILTI
Hole required \varnothing 12-16
Galvanized steel.



B12 - B16 - B20
HILTI
Hole required \varnothing 22-28-32
Galvanized steel.



S8FH - S12FH
HILTI
Hole required \varnothing 6-10
Galvanized steel.
Countersunk.



SF12 - SF16 - SF20 INOX
Hole required \varnothing 14-18-24
Stainless steel.



M12 - M16 INOX
Hole required \varnothing 12-16
Stainless steel.



KIT ROD 70-120
HILTI
Hole required \varnothing 38-56
Galvanized steel.



KIT ROD 70-120 INOX
HILTI
Hole required \varnothing 38-56
Galvanized steel.



AA12 - AA16
Hole required \varnothing 22-22
Galvanized steel.
For asphalt.



ASPHALT CHEMICAL
CHEMICAL ANCHOR
585 ML



FR
HILTI CHEMICAL ANCHOR
300 ML



WIT NORDIC
CHEMICAL ANCHOR
420 ML
(Installation in working cold rooms
with negative temperatures)

In collaboration with



MPM srl reserves the right, at any time, to introduce the necessary changes and improvements to its products.
Any small imperfection in the products and in the materials used are due to the processing method.
Any reproduction of this brochure, even in part, is forbidden.

Fixing accessories



TM5
Hole required \varnothing 8.5
Neutral polyethylene. 100/500 Pcs. / bag.



TS9
Hole required \varnothing 5
White or grey nylon. 1000 Pcs. / bag.



TH
ABS.
100 Pcs./ bag.
RAL 9010 / 9002 / 9006 / 7040 / 7024 / Transparent.



TX12
ABS.
100 Pcs./ bag.
RAL 7035 / 9010



TB14 - TB20
Hole required \varnothing 4-5
Steel / aluminium (white for \varnothing 4)
500 Pcs. / box.

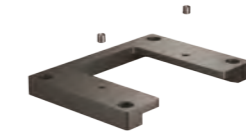

COVER 150 RE
Galvanized steel and painted.



FIX P90
Galvanized steel and painted.

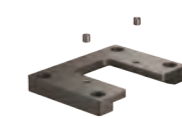

COVER 90 RE
Galvanized steel and painted.



FIX P90 INOX
Stainless steel.



FIX P150
Galvanized steel and painted.



FIX P150 FH
Galvanized steel and painted.
Countersunk.



FIX P150 INOX
Stainless steel.



SHOCK ABSORBER PAD
Soft material, optional for FIXP150.
(To be installed with S12x150)

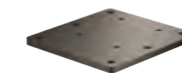

FULL FRAME BASE
Galvanized steel and painted.

Colours

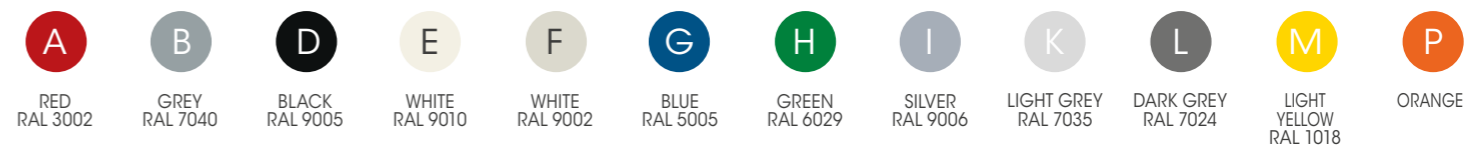

MPM srl reserves the right, at any time, to introduce the necessary changes and improvements to its products.
Any small imperfection in the products and in the materials used are due to the processing method.
Any reproduction of this brochure, even in part, is forbidden.



SOME OF OUR REFERENCES



THE WORLD'S TOP **LOGISTICS**
 PROFESSIONALS CHOOSE OUR
QUALITY MADE IN ITALY



CERTIFICATION



The TÜV SÜD certification was re-confirmed for rack protectors, 100% designed and manufactured by MPM in compliance with European standard EN 15512; Obtaining the TÜV SÜD certification is the confirmation of the company's commitment to the pursuit of qualitative excellence in its products.

Riconfermata la certificazione TÜV SÜD per le protezioni per scaffalature ideate e prodotte da MPM in conformità con la normativa europea EN 15512; L'ottenimento della certificazione TÜV SÜD è la conferma dell'impegno dell'azienda nella ricerca dell'eccellenza qualitativa dei propri prodotti.

La certification TÜV SÜD, attribuée aux protections des montants conçues et fabriquées par MPM conformément à la norme européenne EN 15512, a été reconfirmée. L'obtention de la certification TÜV SÜD confirme bien l'engagement de l'entreprise dans la recherche de l'excellence qualitative de ses produits.

Se confirma nuevamente la certificación TÜV SÜD para las protecciones montadas, diseñadas y fabricadas por MPM de acuerdo con la Norma europea EN 15512; La certificación TÜV SÜD confirma el compromiso de la empresa en la búsqueda de una calidad excelente de sus productos.

OUR CERTIFIED PRODUCTS:

RP, RACK CORNER, LM, GRD 150, PED 90, GRIN 150

OUR INSTALLATION

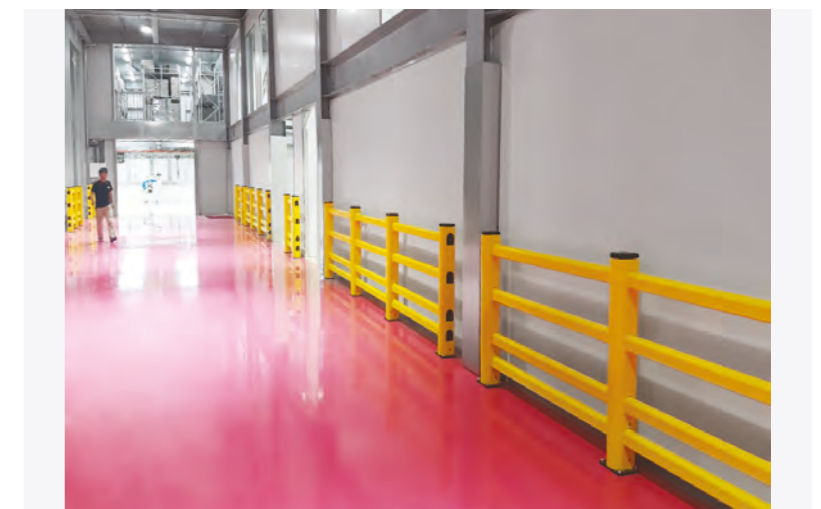
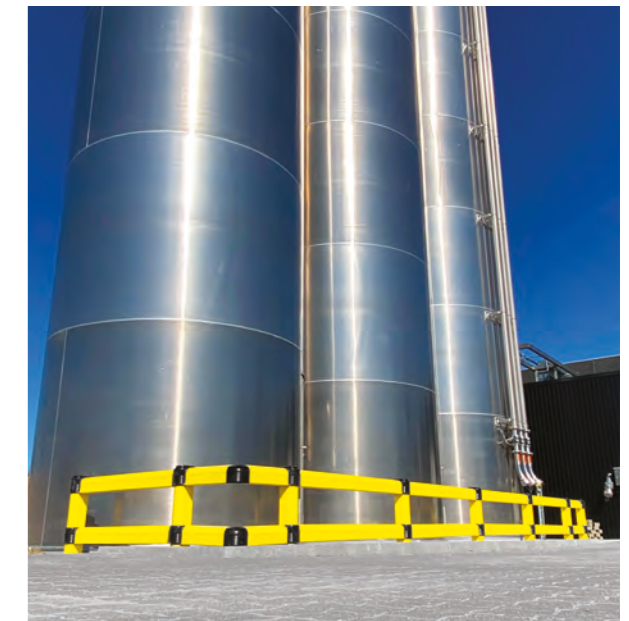

OUR INSTALLATION

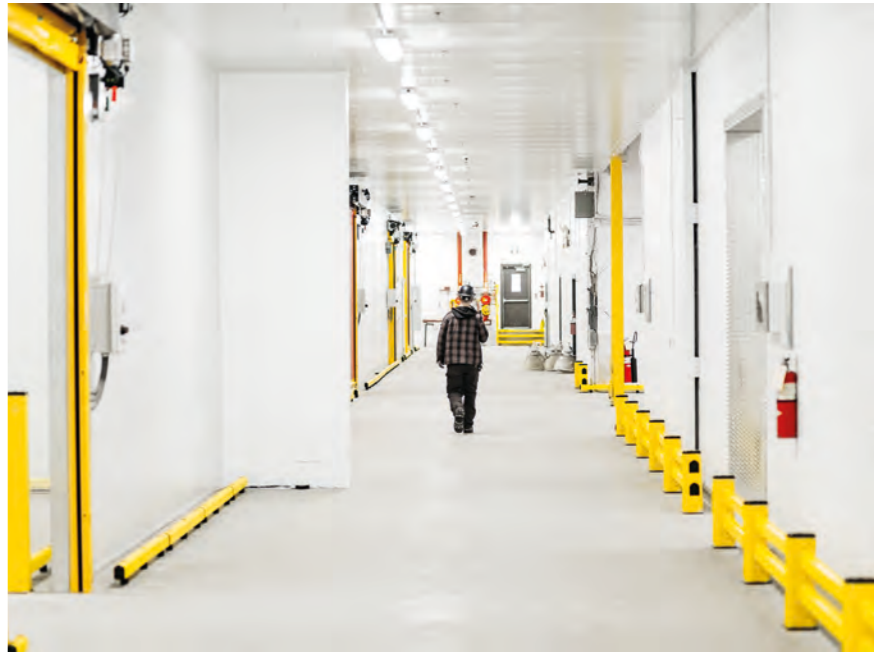

OUR INSTALLATION

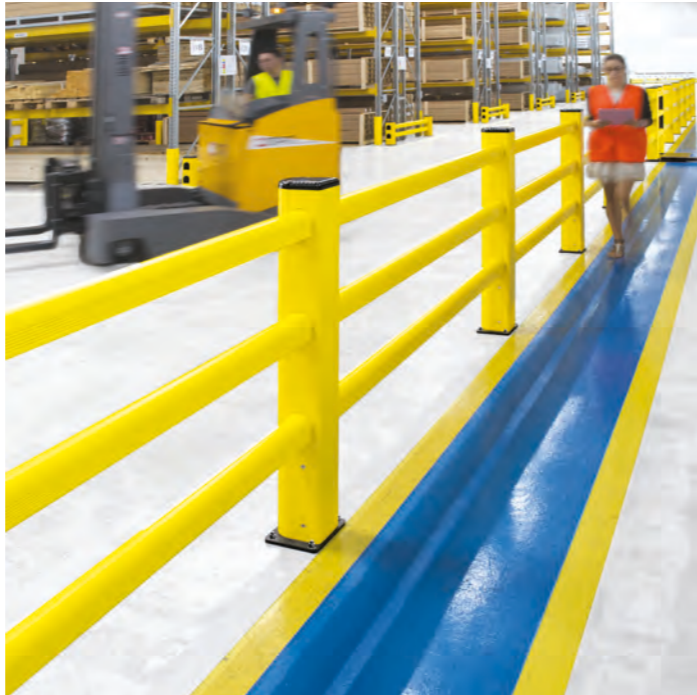

OUR INSTALLATION



MPM states that:

The safety coefficient and consequent use of the products requires the compliance with the appropriate assembling and installation instructions as defined in the technical catalogue on the corporate website www.mpmprotections.com. Therefore, before buying and installing MPM solutions please consult the technical documentation provided by MPM.

Impact resistances indicated in the brochure, or in other documents, refer to laboratory tests and cannot take into account consequences determined by installation methods or peculiarities of the place where the products are installed. In an operational environment there is an almost infinite amount of variables, atmospheric condition, chemical conditions, salinity, exposure to UV light, vehicle type, speed and mass, routes, angles of impact, pedestrian routes, pedestrian behavior, catastrophic events, ground conditions and anchorage.

The data refers to an intact product which length is indicated on the test report and it can be affected by alterations from incorrect maintenance, wear and tear, as well as the methods and characteristics of installation (with specific reference to floor-mounted products); the weight, dimensions, colors and characteristics of the material refer to the sample and the conformity with the latter of the product supplied will be subject to normal production tolerance.

The warranty does not apply in the case of direct installation on asphalt without foundation plinths. Due to the particular nature and variety of this flooring, it is not possible to guarantee the impact resistance.

In addition, in the case of installation with foundation plinths on soil deemed unsuitable, the impact resistance cannot be guaranteed.

The height of the products hereby disclosed is calculated from the uppermost rail. Exception made only for LINK product lines. Length is calculated center to center. The product may be affected by uncontrollable environmental installation conditions. The standard operating temperature of MPM Flexible Protections is generally from +5 °C to +60 °C. For installations in low temperature environments up to -30 °C the alternative Frostex material should be required.

The fastness of the color and its brightness depend on wear and tear and weather conditions that can affect its intensity over time. For outdoor applications exposed to direct sunlight it is possible to choose the specific material Reflex Alpha or grey coloration.

Images in the brochure are for advertising purposes only and do not in any way represent how the products should be used. The images presented in this catalog are for commercial purposes and may not accurately correspond with the actual product. Small variations in color, design, and other features may occur. Full version of MPM products warranty available on corporate website www.mpmprotections.com





MADE IN
ITALY



M.P.M. s.r.l.
Via Europa 2
35010 Fratte
di S. Giustina in Colle
Padova · Italy

T +39 049 9301773
F +39 049 9300427
info@mpmpvc.com
mpmprotections.com

OCTOBER 2024